

Long range and server inspired internet of smart street lights

Rajesh Singh¹, Konda Hari Krishna², Rajesh Kumar³, Anita Gehlot¹, Shaik Vaseem Akram^{1,4},
Sushabhan Chodhury⁵, Yashwant Singh Bisht⁶, Kailash Bisht⁷, Kapil Joshi⁶

¹Division of Research and Innovation, Uttaranchal Institute of Technology, Uttaranchal University, Dehradun, India

²Department of Computer Science and Engineering, Koneru Lakshmaiah Education Foundation, Vaddeswaram, Guntur, India

³Department of Computer Science and Engineering, Meerut Institute of Technology, Meerut, India

⁴Law College Dehradun, Uttaranchal University, Dehradun, India

⁵School of Engineering, University of Petroleum and Energy Studies, Dehradun, India

⁶Uttaranchal Institute of Technology, Uttaranchal University, Dehradun, India

⁷Uttaranchal Institute of Management, Uttaranchal University, Dehradun, India

Article Info

Article history:

Received May 9, 2022

Revised Sep 5, 2022

Accepted Oct 12, 2022

Keywords:

433 MHz

IoT

Light intensity

LoRa

Streetlight

Wi-Fi module

ABSTRACT

Currently, the integration of long-range (LoRa) and the internet of things (IoT) has been widely adopted in various applications for real-time monitoring with reliability. These technologies empower us to achieve the goal of the United Nations for the establishment of an inclusive, safe, resilient, and sustainable environment. The automation, monitoring, and controlling of streetlights is a necessary task for the development of smart infrastructure. With the motivation from the above, this study proposed a LoRa and IoT server-based architecture for automation and controlling of streetlights along with sensors. To implement the proposed architecture, the hardware of the sensor node and gateway based on ATmega 328P, 433 MHz LoRa module, and Wi-Fi module is realized. The realized hardware is deployed in the real-time environment and the sensor node can sense the motion of the object and also records the intensity value on the server through internet connectivity.

This is an open access article under the [CC BY-SA](https://creativecommons.org/licenses/by-sa/4.0/) license.



Corresponding Author:

Shaik Vaseem Akram

Division of Research and Innovation, Uttaranchal Institute of Technology, Law College Dehradun

Uttaranchal University

Dehradun, India

Email: vaseemakram5491@gmail.com

1. INTRODUCTION

According to United Nations, sustainable development goals (SDGs) agenda, the cities need to be inclusive, safe, resilient, and sustainable along with advanced infrastructure [1]. Streetlight is the primary source for providing illumination during the nighttime for a smooth and safe journey for humans and vehicles traveling on the road [2]. Continuous illumination and improper management of lights are the few challenges that existed in streetlights. As a part of smart cities, the lighting system needs to be intelligent, sustainable, and durable. To achieve these targets, the normal lights are replaced with a light-emitting diode (LED) in the streetlights [3]. However, the traditional approach allows them to illuminate streetlights continuously in case of the absence of persons and vehicles on the road. The advancement of the sensors and wireless communication technology empowers to implementation of the intelligent system with the internet of things (IoT) to achieve a smart lighting system [4], [5]. In the previous studies of IoT-based systems, Zigbee communication and global packet radio service (GPRS) as a communication protocol in controlling the streetlight [6], [7]. However, the IoT-based system implemented in the streetlight is powered by a battery source, where the communication protocol like GPRS consumes high energy and the Zigbee transmits only to

the short-range. Long-range (LoRa) communication protocol has gained significant attention and also meets the requirement of IoT for LoRa transmission and low power consumption [8].

To manage energy efficiency and lower energy usage, many local government entities have switched from high-pressure sodium (HPS) lights to LED technology [9]. Since LED street lighting has ten times longer lifespan than HPS, it improves illumination efficiency while using less energy and requiring less maintenance [10]. However, given that streetlights use 43.9 billion kWh of power annually [11], this technique is inadequate to achieve the energy reduction targets. As they account for thirty percent of the world's total energy consumption, streetlights are the main source of energy consumption in cities. In smart cities, the importance of smart infrastructure often plays a vital role. In smart cities, the lighting system heavily relies on road lights to illuminate the light used to guide pedestrians and cars. Through wireless communication, the relevant electric authority is also informed of a lighting system fault. The importance of improving the infrastructure with little complexity and greatest advantages is growing as metropolitan city populations rise. Individual systems are now being implemented in smart cities for managing lighting, monitoring environmental factors, security surveillance and counting vehicles on the road. So, when the lighting system integrates with many apps, it helps city administration keep track of things like humidity, temperature, traffic movement, and security. using a single system. An example of a single system is a smart streetlight. For instance, if the smart streetlight integrates with a security camera and it integrates with intelligence capabilities, and LoRa communication, the security camera recognizes the situation, provides pictures to the emergency unit, and turns on the light to assist.

Smart lights make it feasible for streetlights to deliver flexible services to urban residents in the future [12]. A smart streetlight that can autonomously modify light intensity, act as a wireless fidelity (Wi-Fi) and show weather information, traffic signs, electrical vehicle (EV) charging, video surveillance, and solar-powered energy are now possible because of advances in sensor and LoRa-IoT communication technologies [13] that enable us to access sensor data on the server on the environment, traffic, number of cars, and pedestrians crossing the street light [14]. With the motivation from these aspects, this study proposes a LoRa and IoT server-based architecture [15]–[17] for controlling the streetlight. The main contribution of the study is as follows: i) proposed a LoRa and IoT server-based architecture for automation and controlling of streetlights, ii) the hardware implementation of the proposed architecture is realized in real-time, iii) the sensor values of the LDR sensor are logged on the IoT server, and iv) for establishing the link between the smart streetlights and IoT server, LoRa is coupled with a Wi-Fi module. The organization of the study is as follows: section 2 discusses the state of the art and overview of LoRa-IoT; section 3 covers the proposed system; section 4 illustrates the implementation and results and section 5 covers the conclusion.

2. STATE OF ART AND OVERVIEW OF LORA-IOT

The lighting system plays an important role in providing light on the streetlight. We will discuss the current research on lighting systems and smart cities. The wireless technologies and methods that are implemented in the previous studies are addressed in this study. In addition, we'll go through an overview of LoRa-IoT and related technologies that help create the smart street light in the context of a smart city.

2.1. State of art

Nourillean *et al.* [18] reviewed the applications of IoT-enabled wireless sensor networks (IoT WSN) security problems, and the energy efficiency and routing topologies of ZigBee WSN. Kamasetty *et al.* [19], developed a system that works both with and without internet access to monitor the traffic density and saves it in the cloud. The deployment of IoT smart cities in Bandung is based on IoT network connectivity with six technical evaluation criteria: gateway requirements, traffic/data projection, the best signal level area distribution, and overlapping zones with LoRa wide area network (LoRaWAN), narrow-band IoT (NB-IoT), and random phase multiple access (RPMA) [20]. Khan *et al.* [21] focused on the cyber physical system (CPS) in terms of how crucial it is in the modern environment. In addition, this article examines the significance of CPS and how it relates to the IoT.

Adi and Kitagawa [22] performed LoRa testing dependent on various distances by transmitting barometric pressure, temperature, and humidity sensor through the sensor node with ADR and automatic sleep mode algorithms, and sensor nodes are constructed. Ghasemi and Saberi [23] focused on two elements of the intelligent transportation system and smart governance to uncover the critical elements that would make Birjand city a smarter city. Research by Zainal *et al.* [24], assess the performance of LoRa radio networks under the shadowing effect and a realistic distribution of smart city utility nodes to gain a better understanding of such LoRa technologies. A weather-friendly streetlight control and maintenance system is implemented with the Boltuino (Bolt IoT+Arduino) platform, which combines LDR with an energy-saving LED to adjust light intensity [25]. Developing an ethernet system for communication between a public street

lighting system with integrated control and monitoring based on the IoT, including sensors such as the PZEM-004T and LDR, as well as an Arduino Mega 2560 microprocessor system, relays, and a software graphical user interface (GUI) [26].

A simulation of vehicle and pedestrian traffic is interfaced with a distributed street lighting system with IEC 61499 standard to quantify the energy-saving potential of a street lighting automation system that exploits real-time sensing information of individual road users [27]. Integrate and implement a global system for mobile communication (GSM) module into smart street lights to broadcast an emergency message and change the color of the street light LED to red and also act as a warning signal for approaching cars to detect [28]. Zigbee-based remote street light is developed to control the intensity of the light, where it illuminates street light by detecting vehicle movement, and climatic conditions [29]. Passive infrared (PIR) sensors detect approaching traffic and activate a cluster of lights that encircles it [30] and throughout the day, the light-dependent resistor (LDR) sensor will detect when there is no need for light and the light will be turned off [31]. LED streetlights with various wireless sensors to link to the internet and allow them to monitor and receive the most up-to-date information as well as modify their status remotely [32].

ZigBee technology is being used to construct a smart street lamp control system to reduce excessive fog on the expressway and the major component of the system is the CC2530, which collects temperature and humidity on-site in real-time and uses that data to operate the LED street lamp switch for lighting [33]. Instead of using an astronomical clock and a MOSFET-based driver circuit to control the intensity of an LED array, a microcontroller and real-time clock can be utilized to provide statistical data based on geographic location [34]. IR, PIR, and LDR sensors are used in combination with wireless technology microcontrollers to detect the conditions, and data will be delivered and received as the system is connected to the IoT [35]. Users will be able to track real-time updates and be advised of any changes ahead of time a result, contributing to the development of autonomous street lighting [36].

2.2. Overview of LoRa-IoT

The LoRa-IoT [37]–[40] is a recent communication paradigm that shows the near future, in this, the substances of daily life will be equipped with microcontrollers, mobile communication transmitters, and suitable protocols that will make possible interconnection with other devices and users will indeed become an important part of the new age of the internet [41], [42]. The IoT is a collection of identifiable devices, computerized electronic devices. Information may be sent via a system using wireless communications without the requirement for a PC or human intervention [43]. In the cities and their environment today, the existence of many deficiencies (pollution, fire accidents, and industrial accidents) can be seen, which can be reduced with the use of technology, in this case with the implementation of this paradigm, that of IoT [44], [45], it is possible to increase the awareness in the city. This whole concept can be called safe or smart city [38], [39] which can improve services and effective use of the city's resources. A safe city is characterized by using information and communication technology infrastructure (ICT) [46], human resources, social capital, and industrial resources for economic development, social or environmental sustainability, and high quality of human life. The development brings with it some drawbacks, which if not properly managed can make life in cities unsustainable. Control of air quality and pollution improves our natural environment and thus our quality of life. For this reason, looking for a way to monitor these parameters and bring these analyzes closer to citizens would help improve decision-making. IoT is one of the technologies [47] having inevitable results in nature in the development of computer science and the underlying technology. It aims in serving humanity in various forms, such as virtual reality types of equipment, environmental monitoring equipment, and so on. IoT helps in achieving the complete functionality of a service or a product with minimum or no human intervention or interference [48]–[50].

3. PROPOSED SYSTEM

In smart cities and villages, streetlight plays a crucial role in providing enough light on the roads during dark time. A smart streetlight is a type of illumination that adjusts to the movement of people, bicycles, and automobiles. When no activity is detected, smart street lighting dims; but, when movement is detected, it brightens. This sort of lighting differs from traditional, fixed lighting and dimmable street lighting that dims at predetermined intervals. In this paper, IoT and LoRa radio-based smart motion sensor for smart cities and villages is proposed to reduce energy consumption. Figure 1 shows the proposed architecture for smart streetlights in which it illuminates the light based on vehicles and any other objects passing away from the streetlight. This will also save energy consumption because streetlights will glow only when the vehicle or objects move over the road.

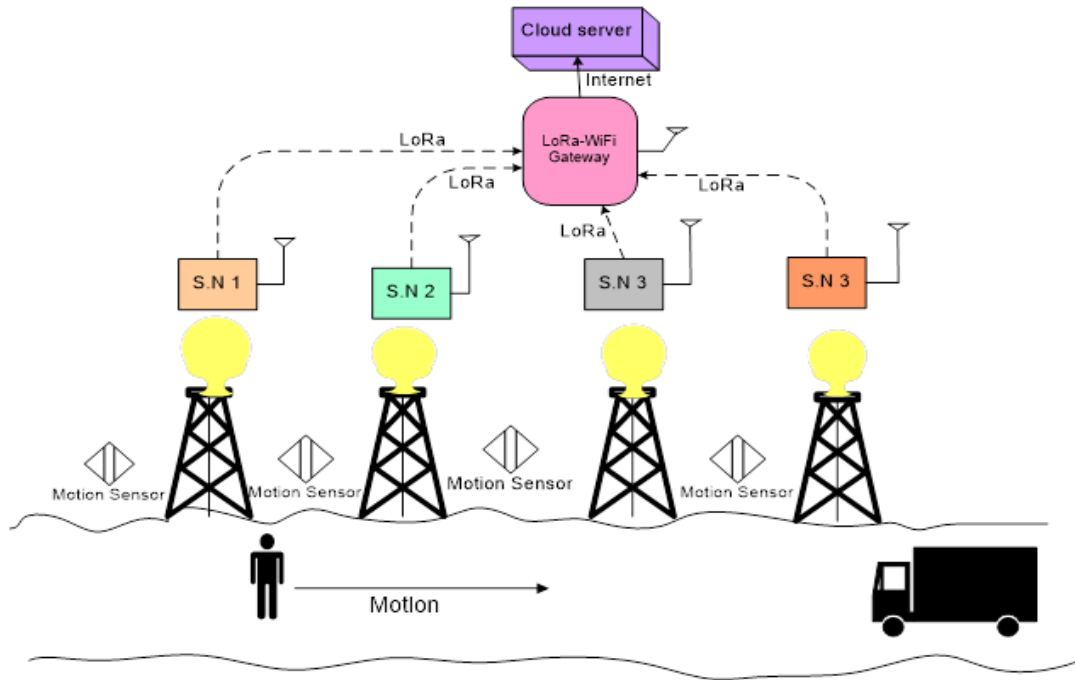

Figure 1. Proposed architecture of smart street lights

In the proposed system, we have used smart motion sensor arrays (S.N.1,M) on a road. The motion sensor interfaced to the controller of the sensor node dims the light based on the movement of the vehicle and human through the light dimmer (Figure 2(a)). The information related to streetlights is transmitted the long range and the control of the streetlight can be implemented from any location, as it is connected to the internet. Figure 2(b) shows the IoT-LoRa gateway which consists of a computing unit, display unit, power supply, Wi-Fi, and LoRa. The computing unit is connected to the Wi-Fi, LoRa, and display unit. The LoRa is embedded in the gateway to receive the information from the sensor node interfaced to the streetlight, while the Wi-Fi module in the gateway enables to connect to the internet for transmitting data on the cloud server [51], [52] and this gateway will be placed in the location where the internet connectivity is stable.

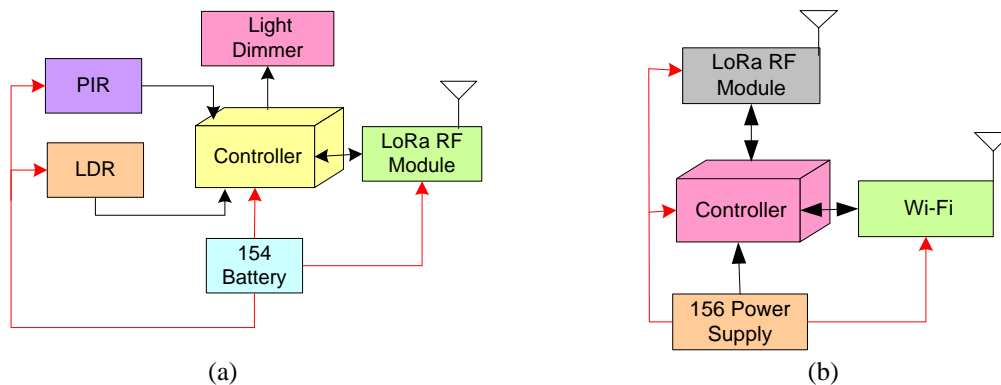

Figure 2. Technological architecture (a) sensor node and (b) gateway

4. IMPLEMENTATION AND RESULTS

The proposed architecture is realized by implementing its hardware in a real-time environment. In the hardware of the sensor node, the ATmega 328P controller and 433 MHz LoRa RF module are integrated

along with PIR and LDR sensors. 433 MHz LoRa RF module established low power WAN between the sensor nodes and the gateway. The hardware of the sensor node also comprises FTDI programmer pins, the distinct voltage converters (+3.3V, +5V), and the different power trails (+12V, +5V, +3.3V, and GND).

FTDI programmer pins enable the load of the firmware, the distinct voltage converters enable to supply of appropriate voltage to the components integrated on the board. In the hardware of IoT-LoRa gateway, ATmega 328P controller, 433 MHz LoRa module are embedded. Along with these components, we have embedded ESP 8266 Wi-Fi module to connect the hardware to the cloud server. After the development of the hardware, the firmware is loaded concerning the application of streetlights. Now the hardware is interfaced to the streetlight, which is located on the university premises and the gateway is positioned where the internet connectivity is available.

Figure 3 illustrates the firmware uploading in the smart motion sensor and IoT-LoRa gateway. Here we have connected the IoT-LoRa gateway on the local IP network through the IP address 192.168.204.164. The sensor node is deployed in the streetlight of the university campus and the gateway is placed far away from the sensor node. Figure 4 illustrates the light intensity sensor values (LUX) that are obtained from the light intensity sensor of the sensor node. The recorded light intensity value of the sensor node is 6.0 LUX. The motion sensor embedded in the sensor node activates and controls the intensity of the streetlight through a light dimmer. The status of each streetlight can also be viewed on the local server as ON/OFF. Moreover, based on the intensity of the light, the streetlight also regulates the light intensity through a light dimmer. The sensor values of the light intensity are logged on the cloud server through LoRa and internet connectivity. The visualization of LUX values and the status of the light enables authorities to visualize the real-time status of light from any location through internet connectivity.

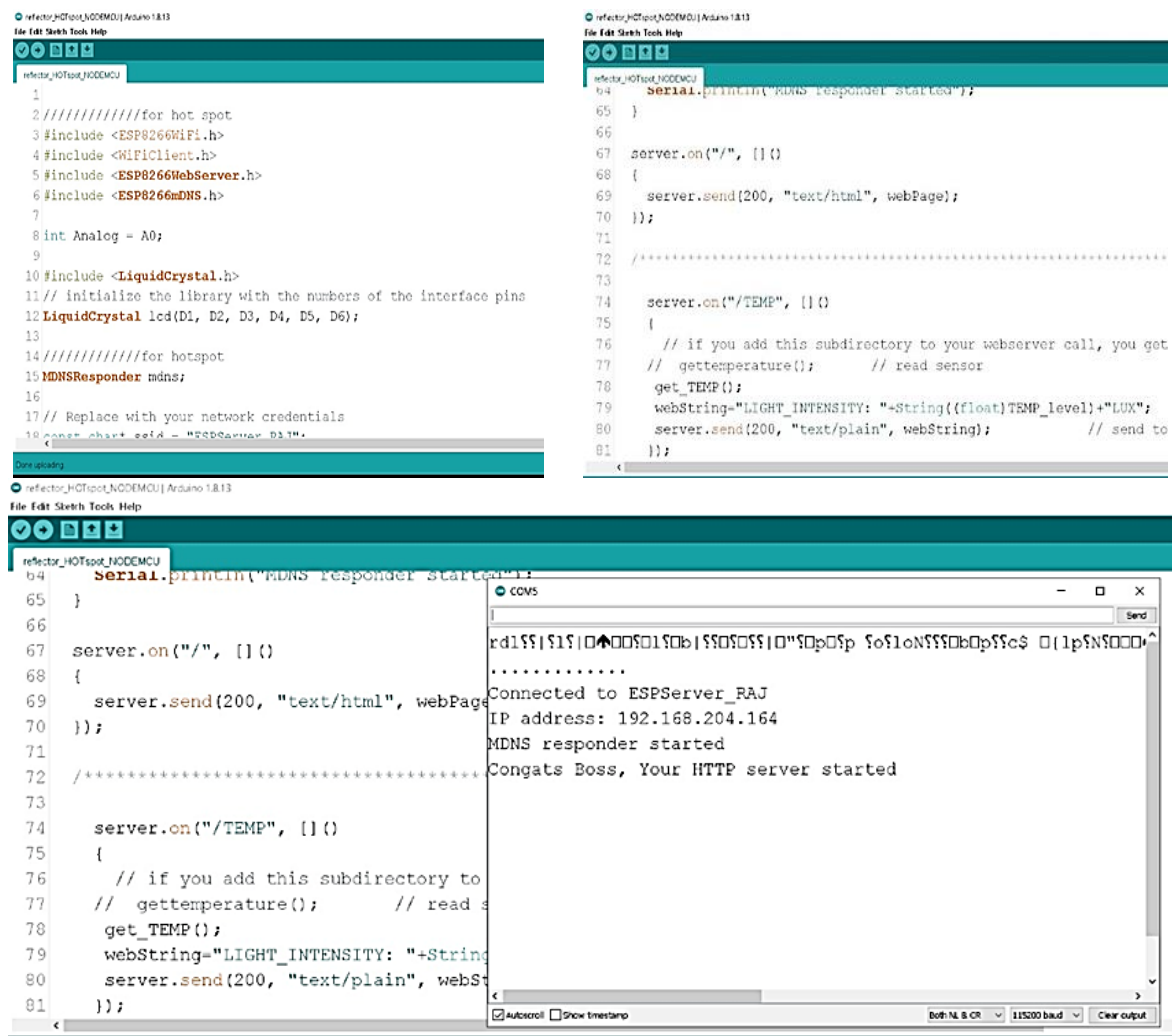

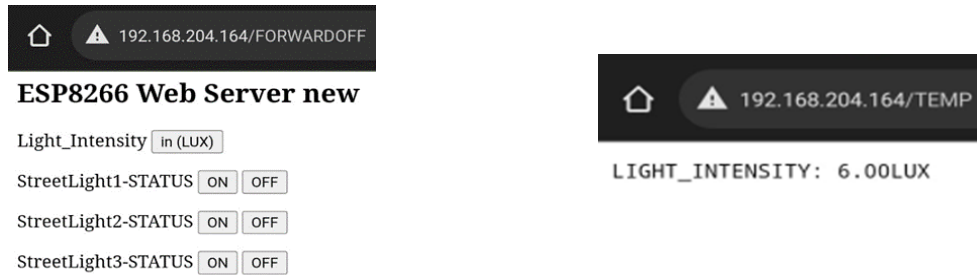

Figure 4. Sensor values on the server

5. CONCLUSION

Nowadays, the convergence of LoRa and IoT has been extensively employed in a variety of applications for reliable real-time monitoring. Streetlight automation, monitoring, and control are major requirements for the development of smart infrastructure. This study aims to implement a smart street lighting system based on a 433 MHz LoRa and Wi-Fi module. For the implementation, the hardware of the sensor node and gateway is implemented in real-time. The PIR sensor in the sensor node empowers to turn on/off the light through the light dimmer. The light intensity value from the LDR sensor and the status of the streetlight is visualized on the server.

REFERENCES



- [1] "Cities - United Nations Sustainable Development Action 2015," *United Nations Sustainable Development*. [Online], Available at: <https://www.un.org/sustainabledevelopment/cities/>
- [2] S. Nagamani, J. M. Reddy, G. Lavanya, and A. L. H. Chandana, "Smart Street Light Management System Using Internet of Things," in *2019 International Conference on Intelligent Computing and Control Systems (ICCS)*, May 2019, pp. 103–107, doi: 10.1109/iccs45141.2019.9065477.
- [3] N. Ouerhani, N. Pazos, M. Aeberli, and M. Muller, "IoT-based dynamic street light control for smart cities use cases," in *2016 International Symposium on Networks, Computers and Communications (ISNCC)*, May 2016, pp. 1–5, doi: 10.1109/isncc.2016.7746112.
- [4] G. B. Satrya, H. T. Reda, K. J. Woo, P. T. Daely, S. Y. Shin, and S. Chae, "IoT and Public Weather Data Based Monitoring and Control Software Development for Variable Color Temperature LED Street Lights," *International Journal on Advanced Science, Engineering and Information Technology*, vol. 7, no. 2, p. 366, Apr. 2017, doi: 10.18517/ijaseit.7.2.1578.
- [5] F. Leccese and Z. Leonowicz, "Intelligent wireless street lighting system," in *2012 11th International Conference on Environment and Electrical Engineering*, May 2012, pp. 958–961, doi: 10.1109/eeeic.2012.6221515.
- [6] A. Lavric, V. Popa, C. Males, and I. Finis, "A performance study of ZigBee wireless sensors network topologies for street lighting control systems," in *2012 International Conference on Selected Topics in Mobile and Wireless Networking*, Jul. 2012, pp. 130–133, doi: 10.1109/icost.2012.6271280.
- [7] M. C. V. S. Mary, G. P. Devaraj, T. A. Theepak, D. J. Pushparaj, and J. M. Esther, "Intelligent Energy Efficient Street Light Controlling System based on IoT for Smart City," in *2018 International Conference on Smart Systems and Inventive Technology (ICSSIT)*, Dec. 2018, pp. 551–554, doi: 10.1109/icssit.2018.8748324.
- [8] Q. Zhou, K. Zheng, L. Hou, J. Xing, and R. Xu, "Design and Implementation of Open LoRa for IoT," *IEEE Access*, vol. 7, pp. 100649–100657, 2019, doi: 10.1109/access.2019.2930243.
- [9] S. Escolar, J. Carretero, M.-C. Marinescu, and S. Chessa, "Estimating Energy Savings in Smart Street Lighting by Using an Adaptive Control System," *International Journal of Distributed Sensor Networks*, vol. 10, no. 5, p. 971587, May 2014, doi: 10.1155/2014/971587.
- [10] M. I. Masoud, "Street lighting using solar powered LED light technology: Sultan Qaboos University Case Study," in *2015 IEEE 8th GCC Conference and Exhibition*, Feb. 2015, pp. 1–6, doi: 10.1109/ieegcc.2015.7060015.
- [11] G. Liu, "Sustainable feasibility of solar photovoltaic powered street lighting systems," *International Journal of Electrical Power and Energy Systems*, vol. 56, pp. 168–174, Mar. 2014, doi: 10.1016/j.ijepes.2013.11.004.
- [12] C. P. Vega, K. M. Zielinska-Dabkowska, and F. Hölker, "Urban Lighting Research Transdisciplinary Framework—A Collaborative Process with Lighting Professionals," *International Journal of Environmental Research and Public Health*, vol. 18, no. 2, p. 624, Jan. 2021, doi: 10.3390/ijerph18020624.
- [13] S. Umamaheswari, "Smart Street Lighting in Smart Cities: A Transition from Traditional Street Lighting," in *Studies in Systems, Decision and Control*, Springer International Publishing, 2020, pp. 117–133, doi: 10.1007/978-3-030-53149-2_6.
- [14] P. Asghari, A. M. Rahmani, and H. H. S. Javadi, "Internet of Things applications: A systematic review," *Computer Networks*, vol. 148, pp. 241–261, Jan. 2019, doi: 10.1016/j.comnet.2018.12.008.
- [15] S. Bagwari, A. Gehlot, R. Singh, N. Priyadarshi, and B. Khan, "Low-Cost Sensor-Based and LoRaWAN Opportunities for Landslide Monitoring Systems on IoT Platform: A Review," *IEEE Access*, vol. 10, pp. 7107–7127, 2022, doi: 10.1109/access.2021.3137841.
- [16] C. L. Narayana, R. Singh, and A. Gehlot, "Performance evaluation of LoRa based sensor node and gateway architecture for oil pipeline management," *International Journal of Electrical and Computer Engineering (IJECE)*, vol. 12, no. 1, p. 974, Feb. 2022, doi: 10.11591/ijece.v12i1.pp974-982.
- [17] J. H. Majeed and Q. Aish, "A remote patient monitoring based on WBAN implementation with internet of thing and cloud server," *Bulletin of Electrical Engineering and Informatics*, vol. 10, no. 3, pp. 1640–1647, Jun. 2021, doi: 10.11591/eei.v10i3.1813.

- [18] S. W. Nourillean, M. D. Hassib, and Y. A. Mohammed, "Internet of things based wireless sensor network: a review," *Indonesian Journal of Electrical Engineering and Computer Science*, vol. 27, no. 1, p. 246, Jul. 2022, doi: 10.11591/ijeecs.v27.i1.pp246-261.
- [19] B. Kamasetty, M. Renduchintala, L. L. Shetty, S. Chandarshekar, and R. Shettar, "Design and development of portable smart traffic signaling system with cloud-artificial intelligence enablement," *Indonesian Journal of Electrical Engineering and Computer Science*, vol. 26, no. 1, p. 116, Apr. 2022, doi: 10.11591/ijeecs.v26.i1.pp116-126.
- [20] M. I. Nashiruddin, M. T. B. Sihotang, and M. A. Murti, "Comparative study of low power wide area network based on internet of things for smart city deployment in Bandung city," *Indonesian Journal of Electrical Engineering and Computer Science*, vol. 25, no. 1, p. 425, Jan. 2022, doi: 10.11591/ijeecs.v25.i1.pp425-439.
- [21] F. Khan, R. L. Kumar, S. Kadry, Y. Nam, and M. N. Meqdad, "Cyber physical systems: A smart city perspective," *International Journal of Electrical and Computer Engineering (IJECE)*, vol. 11, no. 4, p. 3609, Aug. 2021, doi: 10.11591/ijece.v11i4.pp3609-3616.
- [22] P. D. P. Adi and A. Kitagawa, "A performance of radio frequency and signal strength of LoRa with BME280 sensor," *TELKOMNIKA (Telecommunication Computing Electronics and Control)*, vol. 18, no. 2, pp. 649-660, Apr. 2020, doi: 10.12928/telkomnika.v18i2.14843.
- [23] A. Ghasemi and M. Saberi, "The key factors in transforming Birjand city to a smart city: smart mobility, smart government," *Indonesian Journal of Electrical Engineering and Computer Science*, vol. 19, no. 1, pp. 317-324, Jul. 2020, doi: 10.11591/ijeecs.v19.i1.pp317-324.
- [24] N. A. B. Zainal, M. H. Habaebi, I. J. Chowdhury, M. R. Islam, and J. I. Daoud, "Gateway sink placement for sensor node grid distribution in lora smart city networks," *Indonesian Journal of Electrical Engineering and Computer Science*, vol. 14, no. 2, pp. 834-842, May 2019, doi: 10.11591/ijeecs.v14.i2.pp834-842.
- [25] D. Saha, S. M. Sorif, and P. Dutta, "Weather Adaptive Intelligent Street Lighting System With Automatic Fault Management Using Boltuino Platform," in *2021 International Conference on ICT for Smart Society (ICISS)*, Aug. 2021, pp. 1-6, doi: 10.1109/iciss53185.2021.9533234.
- [26] A. Adriansyah, S. Budiyanto, J. Andika, A. Romadlan, and N. Nurdin, "Public street lighting control and monitoring system using the internet of things," *AIP Conference Proceedings*, vol. 2217, no. 1, 2020, doi: 10.1063/5.0000594.
- [27] C.-W. Yang, E. Nefedov, S. Sierla, and P. Flikkema, "Vehicle and pedestrian aware street lighting automation," in *2015 IEEE 13th International Conference on Industrial Informatics (INDIN)*, Jul. 2015, pp. 1269-1274, doi: 10.1109/indin.2015.7281917.
- [28] Rajat, N. Kumar, and M. Sharma, "Smart Street Lights to Reduce Death Rates from Road Accidents," in *Proceedings of International Conference on Recent Trends in Machine Learning, IoT, Smart Cities and Applications*, Springer Singapore, 2020, pp. 795-809, doi: 10.1007/978-981-15-7234-0_75.
- [29] B. Kul, "IoT-GSM-based high-efficiency LED street light control system (IoT-SLCS)," in *2017 XXVI International Scientific Conference Electronics (ET)*, Sep. 2017, pp. 1-5, doi: 10.1109/et.2017.8124361.
- [30] B. Abinaya, S. Gurupriya, and M. Pooja, "IoT based smart and adaptive lighting in street lights," in *2017 2nd International Conference on Computing and Communications Technologies (ICCCCT)*, Feb. 2017, pp. 195-198, doi: 10.1109/icccct.2017.7972267.
- [31] S. A. Bhosale and T. Ankalkote, "Modern Street Lighting System with Intensity Control based on Vehicle Movements and Atmospheric Conditions using Zigbee," in *2018 International Conference on Information, Communication, Engineering and Technology (ICICET)*, Aug. 2018, pp. 1-4, doi: 10.1109/icicet.2018.8533817.
- [32] K. A. Bhukya, S. Ramasubbareddy, K. Govinda, and T. A. S. Srinivas, "Adaptive Mechanism for Smart Street Lighting System," in *Smart Intelligent Computing and Applications*, Springer Singapore, 2019, pp. 69-76, doi: 10.1007/978-981-32-9690-9_8.
- [33] M. Kokilavani and A. Malathi, "Smart Street Lighting System using the IoT," *International Journal of the Advanced Research in Applied Science and Technology*, vol. 3, no. 11, Nov. 2017.
- [34] K. Praghash, E. Dhathri, S. Arunmetha, N. M. Reddy, P. Kanakaraja, and S. Guruju, "Design and Implementation of IoT based Smart Streetlights Systems," in *2021 Fifth International Conference on I-SMAC (IoT in Social, Mobile, Analytics and Cloud) (I-SMAC)*, Nov. 2021, pp. 248-252, doi: 10.1109/i-smac52330.2021.9640776.
- [35] X. Chen, "The Intelligent Street Light Control System for Preventing Heavy Fog of Expressway Based on ZigBee," *Wireless Personal Communications*, vol. 121, no. 1, pp. 353-359, Sep. 2021, doi: 10.1007/s11277-021-08639-1.
- [36] V. S. Priya and M. Vijayan, "Automatic street light control system using wsn based on vehicle movement and atmospheric condition," *International Journal of communication and computer Technologies*, vol. 5, no. 1, pp. 6-11, 2017, doi: 10.31838/ijccts/05.01.02.
- [37] A. Rana *et al.*, "A Long-Range Internet of Things-Based Advanced Vehicle Pollution Monitoring System with Node Authentication and Blockchain," *Applied Sciences*, vol. 12, no. 15, p. 7547, Jul. 2022, doi: 10.3390/app12157547.
- [38] Kallappa and B. B. Tigadi, "Industrial Safety Parameters Monitoring inIoT Environment," *International Journal of Advanced Research in Electrical, Electronics and Instrumentation Engineering*, vol. 5, no. 6, pp. 5511-5516, Jun. 2016, doi: 10.15662/IJAREEIE.20156.0506128.
- [39] T. J. Wallington, J. L. Sullivan, and M. D. Hurley, "Emissions of CO₂, CO, NO_x, HC, PM, HFC-134a, N₂O and CH₄ from the global light duty vehicle fleet," *Meteorologische Zeitschrift*, vol. 17, no. 2, pp. 109-116, Apr. 2008, doi: 10.1127/0941-2948/2008/0275.
- [40] F. Doctor, H. Hagra, and V. Callaghan, "A Fuzzy Embedded Agent-Based Approach for Realizing Ambient Intelligence in Intelligent Inhabited Environments," *IEEE Transactions on Systems, Man, and Cybernetics - Part A: Systems and Humans*, vol. 35, no. 1, pp. 55-65, Jan. 2005, doi: 10.1109/tsmca.2004.838488.
- [41] S. Balamurugan and D. Saravanakamalam, "Energy monitoring and management using internet of things," in *2017 International Conference on Power and Embedded Drive Control (ICPEDC)*, Mar. 2017, pp. 208-212, doi: 10.1109/icpedc.2017.8081088.
- [42] R. A. Karthika, S. Rahamtula, and Y. Anusha, "Internet of things for industrial monitoring and control applications," *International Journal of Engineering and Technology*, vol. 7, no. 2.21, p. 280, Apr. 2018, doi: 10.14419/ijet.v7i2.12381.
- [43] A. S. Rawat, J. Rajendran, H. Ramiah, and A. Rana, "LoRa (Long Range) and LoRaWAN Technology for IoT Applications in COVID-19 Pandemic," in *2020 International Conference on Advances in Computing, Communication and Materials (ICACCM)*, Aug. 2020, pp. 419-422, doi: 10.1109/icaccm50413.2020.9213067.
- [44] J. Gubbi, R. Buyya, S. Marusic, and M. Palaniswami, "Internet of Things (IoT): A vision, architectural elements, and future directions," *Future Generation Computer Systems*, vol. 29, no. 7, pp. 1645-1660, Sep. 2013, doi: 10.1016/j.future.2013.01.010.
- [45] L. D. Xu, W. He, and S. Li, "Internet of Things in Industries: A Survey," *IEEE Transactions on Industrial Informatics*, vol. 10, no. 4, pp. 2233-2243, Nov. 2014, doi: 10.1109/tii.2014.2300753.
- [46] A. Monzon, "Smart Cities Concept and Challenges: Bases for the Assessment of Smart City Projects," in *Communications in Computer and Information Science*, Springer International Publishing, 2015, pp. 17-31, doi: 10.1007/978-3-319-27753-0_2.



- [47] S. Alam, A. Fatima, and M. S. Butt, "Sustainable development in Pakistan in the context of energy consumption demand and environmental degradation," *Journal of Asian Economics*, vol. 18, no. 5, pp. 825–837, Oct. 2007, doi: 10.1016/j.asieco.2007.07.005.
- [48] A. Iera, C. Floerkemeier, J. Mitsugi, and G. Morabito, "The Internet of things [Guest Editorial]," *IEEE Wireless Communications*, vol. 17, no. 6, pp. 8–9, Dec. 2010, doi: 10.1109/mwc.2010.5675772.
- [49] S. Hong *et al.*, "SNAIL: an IP-based wireless sensor network approach to the internet of things," *IEEE Wireless Communications*, vol. 17, no. 6, pp. 34–42, Dec. 2010, doi: 10.1109/mwc.2010.5675776.
- [50] S. D. T. Kelly, N. K. Suryadevara, and S. C. Mukhopadhyay, "Towards the Implementation of IoT for Environmental Condition Monitoring in Homes," *IEEE Sensors Journal*, vol. 13, no. 10, pp. 3846–3853, Oct. 2013, doi: 10.1109/jksen.2013.2263379.
- [51] X. Xu, A. Zhan, and X. Li, "Design and implementation of street light control system based on power line carrier communication," *Procedia Computer Science*, vol. 155, pp. 734–739, 2019, doi: 10.1016/j.procs.2019.08.106.
- [52] A. Ghosh, P. K. Kundu, and G. Sarkar, "Design and Real-Time Implementation of Cloud based Indoor Illumination Monitoring System," *Journal of The Institution of Engineers (India): Series B*, vol. 101, no. 3, pp. 223–227, May 2020, doi: 10.1007/s40031-020-00448-7.

BIOGRAPHIES OF AUTHORS





Dr. Rajesh Singh    is currently associated with Uttaranchal University as Professor and Director (R&I) with more than seventeen years of experience in academics. He has been featured among top ten inventors for ten years 2010-2020, by Clarivate Analytics in "India's Innovation Synopsis" in March 2021 for filing Three hundred and fifty-eight patents. He has 41 patents granted (National and International), 5 PCT, 5 technology transfer and published more than 150 research articles in SCI/Scopus journals. He has published thirty-four books in the area of embedded systems and internet of things with reputed international publishers. He can be contacted at email: drrajeshsingh004@gmail.com.





Konda Hari Krishna    working as an Assistant professor in Department of CSE, Koneru Lakshmaiah Education Foundation, Vaddeswaram, Guntur district, A.P. He received his Doctorate Degree Ph.D. in Computer Science and Engineering from LINGAYA's VIDYAPEETH Deemed to be University, Faridabad, HARYANA. He published Various Research Papers in Various International Journals of Reputed and Presented Research papers in Conferences and Seminars and his research area is improvement of network lifetime using clustering and dynamic topology methods in WSN. He was awarded recently with Best Young Faculty, Researcher and Academic Excellence in 2022. He can be contacted at email: kharikrishna396@gmail.com.





Dr. Rajesh Kumar    is working as a Professor in Computer Science Department at Meerut Institute of Technology, Partapur Meerut. He has done MBA (MKT,IT), MCA, M.Tech (CS), Ph.D Computer science engineering and Ph.D. in Management. His area of interest in computer science includes, data science, cloud computing, computer networks, software engineering, E-commerce, and in management, it is business research as well as management information system, blockchain and digital marketing. He can be contacted at email: rajesh.Kumar1@mitmeerut.ac.in.



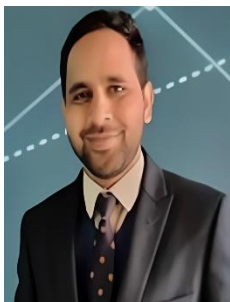

Dr. Anita Gehlot    is currently associated with Uttaranchal University as a Professor and Head (R&I) with more than Fifteen years of experience in academics. She has been featured among top ten inventors for ten years 2010-2020, by Clarivate Analytics in "India's Innovation Synopsis" in March 2021 for filing two hundred and sixty-three patents. She has 41 patents granted (National and International), 5 PCT, 5 technology transfer and published 150 research articles in SCI/Scopus journals. She has published thirty-four books in the area of Embedded Systems and internet of things with reputed international publishers. She can be contacted at email: dranitagehlot@gmail.com.





Dr. Shaik Vaseem Akram    is currently working as an Assistant Professor in the Department of Research and Innovation, Uttarakhand University Dehradun. He has completed Ph.D. in Electronics and Communication Engineering at Lovely Professional University, Punjab. He has published 25 SCI articles in high-impact factor journals in the area of IoT and Industry 4.0. He has one patent granted in the area of waste management and published more than 160 patents. He can be contacted at email: vaseemakram5491@gmail.com.





Dr. Sushabhan Chodhury    is currently working as a Professor in the department of Department of Electrical and Electronics Engineering, School of Engineering, UPES, Dehradun. He has published more than 50 research papers in international/national journals and conferences. He has filed 13 patents and authored several books. He is selected as an outstanding scientist of the twenty-first century by Cambridge Biographical Centre. His research interests include wireless sensor networks, embedded systems, robotics, automation and control, the IoT (Node-MCU, ESP8266), nanotechnology, artificial intelligence, and machine learning. He can be contacted at email: schoudhury@ddn.upes.ac.in





Yashwant Singh Bisht    is currently working as an Assistant Professor in the Department of Mechanical Engineering, Uttarakhand University Dehradun. He is Pursuing Ph.D. in Mechanical Engineering at Uttarakhand University, Uttarakhand India. He has published 2 articles which is Scopus indexed in the area of IoT and Industry 4.0 WEDM. He has published more than 32 patents. He can be contacted at email: yashwantb3@gmail.com.



Kailash Bisht    is currently working as an Assistant Professor in the Department of Management, Uttarakhand University, Dehradun with an experience of teaching more than 5 years. He can be contacted at email: Kailash.Bisht1911@gmail.com.



Dr. Kapil Joshi    is currently working as an Assistant Professor in the department of Computer Science and AMP; Engineering (CSE) at Uttarakhand Institute of Technology (UIT), Uttarakhand University, Dehradun. He has around 8 years of academic experience in different institutions/Companies. His areas of interest are operating system, computer networks, web technology, data structure, and java. He can be contacted at email: Kapilengg0509@gmail.com.