

## Simulation of 3D-space vector modulation for neutral point clamped inverters

Palanisamy Ramasamy<sup>1</sup>, Ramkumar Ravindran<sup>2</sup>, Neetu Gupta<sup>3</sup>, Gunjan Sardana<sup>3</sup>, Indumathi Sekar<sup>4</sup>, Venugopala Aparna Marthanda<sup>5</sup>, Selvakumar Kuppusamy<sup>1</sup>

<sup>1</sup>Department of Electrical and Electronics Engineering, SRM Institute of Science and Technology, Kattankulathur, India

<sup>2</sup>Department of Electrical and Electronics Engineering, Dhanalakshmi Srinivasan University, Samayapuram, Tiruchirappalli, India

<sup>3</sup>Department of Electronics Engineering, J.C. Bose University of Science and Technology, YMCA, Faridabad, India

<sup>4</sup>Department: Electronics and Communication Engineering, R.M.D. Engineering College, R.S.M. Nagar, Kavaraipeitai, India

<sup>5</sup>Department of Electrical and Electronics Engineering, LakiReddy BaliReddy College Engineering, Mylavaram, India

### Article Info

#### Article history:

Received Aug 2, 2022

Revised Nov 7, 2022

Accepted Dec 1, 2022

#### Keywords:

3D space vector modulation

Neutral point multilevel inverter

Pulse width modulation

Total harmonic distortion

### ABSTRACT

This paper gives an idea to simulation of three-dimensional space vector modulation for neutral point clamped multilevel inverter. Three dimensional-space vector modulation (3D-SVM) algorithm is progressed method of two dimensional-space vector modulation (2D-SVM) algorithm; it leads to reduce the complexity in reference vector identification and switching time calculation, also it includes the various advantages of 2D-SVM like minimized total harmonic distortion, reduced EMI issues. A simple system for the assortment of switching state vectors to track the reference voltage vectors without using any redundant switching vectors. This proposed method tracks the reference vector by identifying subcubes and prisms by using mathematical conditions. Here the cost of the proposed technique is independent of voltage levels of inverter. This paper realizes the accomplishment of 3D-SVM using a neutral point clamped inverter. The simulation results of the proposed method are verified using MATLAB/Simulink.

This is an open access article under the [CC BY-SA](https://creativecommons.org/licenses/by-sa/4.0/) license.



### Corresponding Author:

Selvakumar Kuppusamy

Department of Electrical and Electronics Engineering, SRM Institute of Science and Technology

Potheri, SRM Nagar, Kattankulathur, Tamil Nadu 603203, India

Email: selvakse@gmail.com

## 1. INTRODUCTION

Multilevel inverters have grown much concentration in the application of medium voltage and high power due to their better presentation evaluated to two level inverters [1]-[4]. Space vector modulation (SVM) is a digital switching pulses generation method, where uses the control variable agreed by the control system and identifies each switching vector as a point in complex space. Used to the control of pulses for switches of multilevel inverter. Prats *et al.* [5] eliminates the total harmonic distortion (THD). It SVM is a digital pulse width modulated (PWM) scheme so to control the selected switch state duty cycle is easy [6]. Maximum utilization of DC link voltage and operating in entire modulation region. SVM and sinusoidal (SPWM) are introduced under pulse width modulation techniques from these SPWM not used to assess each switching state present in multilayer inverter. Both 2D and 3D implementations of SVM are used [7]-[9].

The three-phase n-level inverter for vector modulation in two dimensions comprises six sectors and  $n^3$  switching states (for three levels,  $3^3=27$  switching states) [10]. Each sector in the SVM should include  $(n-1)^2$  triangles (4 triangles in each sector). There are 3 zero vectors, 12 small vectors, 6 medium vectors, and 6 large

vectors [11]. The complexity is caused by the challenge of fermentative the reference vector's position, the computation of on-times, and the strength and variety of switching states [12].

Tetrahedron identification in a cube is used in the construction of three-dimensional space vector modulation utilizing a diode-clamped multilevel inverter, along with challenging matrix calculations to determine switching times [13], [14]. This offers a modulation method for use in all programmes that offer 3D vector control. This generalized technique, which computes the nearest switching vectors in sequence to the reference vector online and computes duty cycles using trigonometric functions and some look-up table values [15], [16].

Using a method that gives a broad overview of the modulation characteristics, the 3D SVM is implemented. The approach eliminates the need for tetrahedron identification and lookup tables to compute duty cycles and is independent of the number of layers [17]. The concept of switching the state vectors closest to reference voltage vectors forms the basis of the algorithm for determining the state vectors. The lookup tables were used to calculate the switching state vectors and their ON times. The procedure can then be used to any number of phases [18]. Three phase inverters can now use a multilayer, multiphase space vector PWM method, and prior SVPWM methods are contrasted with this multiphase algorithm [19], [20].

## 2. SPACE VECTOR MODULATION FOR 3-LEVEL NPC MLI

There is just one switching state per vertices in a 3D space vector modulation; there are no redundant switching states [21]-[25]. We may analyze each switching state as a result. Calculations in mathematics are easy. No need to determine angles or do transformations. The technique of 3D space vector modulation is implemented in Figure 1.

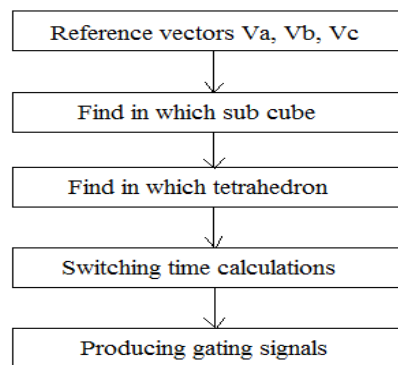

Figure 1. Process of 3D SVM

Here reference voltage vector is decomposed into two components as (1):

$$V_{ref} = V_0 + V_t \quad (1)$$

where  $V_0$  is off set voltage and  $V_t$  is two level voltage. In a-b-c coordinates, it is expressed as (2):

$$\begin{bmatrix} V_{refa} \\ V_{refb} \\ V_{refc} \end{bmatrix} = \begin{bmatrix} V_{0a} \\ V_{0b} \\ V_{0c} \end{bmatrix} + \begin{bmatrix} V_{tla} \\ V_{tlb} \\ V_{tlc} \end{bmatrix} \quad (2)$$

The offset component written as (3):

$$v_0 = \begin{bmatrix} v_{0a} \\ v_{0b} \\ v_{0c} \end{bmatrix} + \begin{bmatrix} \text{int}(v_{refa}) \\ \text{int}(v_{refb}) \\ \text{int}(v_{refc}) \end{bmatrix} \quad (3)$$

The reference voltage is summation of the offset voltage and two-level components  $V_t$  is defined as (4):

$$v_t = v_{ref} - v_0 = \begin{bmatrix} v_{tla} \\ v_{tlb} \\ v_{tlc} \end{bmatrix} \quad (4)$$

Because the reference vector in a 2D SVM has redundant switching states, identifying it might be challenging. Therefore, mathematical analysis is easy. It is quite simple to investigate each switching state. In

contrast to complete harmonic distortion and 2D-space vector modulation, reference vector identification is simpler, which should lessen the voltage stress on the devices. The Figure 2 shows the 3D-SVM cube diagram.

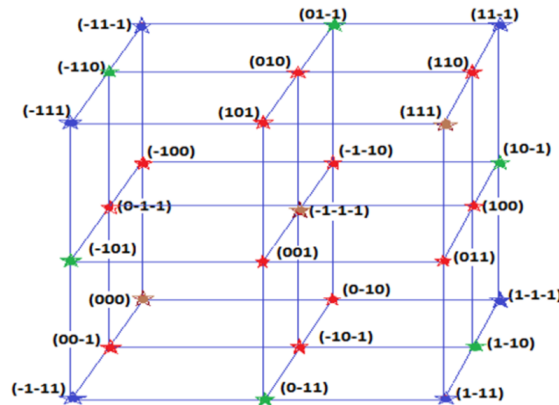

Figure 2. 3D-SVM cube diagram

Tetrahedrons for vector modulation should be positioned in each subcube in 3D space. Each subcube contains a tetrahedron with six faces. Therefore, the tetrahedron that the reference vector is pointing at needs to be defined. Using normalized reference vectors (Xa, Xb, and Xc), it is simple to identify this tetrahedron; the process is comparable to subcube identification. The 3D region is the phase difference between these three planes. The Figure 3 shows the representation of tetrahedrons in each subcube. The values of the normalized reference vector are,

$$\begin{aligned}
 U_a &= S_a^1 d_1 + s_a^2 d_2 + S_a^3 d_3 + S_a^4 d_4 \\
 U_b &= S_b^1 d_1 + s_b^2 d_2 + S_b^3 d_3 + S_b^4 d_4 \\
 U_c &= S_c^1 d_1 + s_c^2 d_2 + S_c^3 d_3 + S_c^4 d_4
 \end{aligned}
 \tag{5}$$

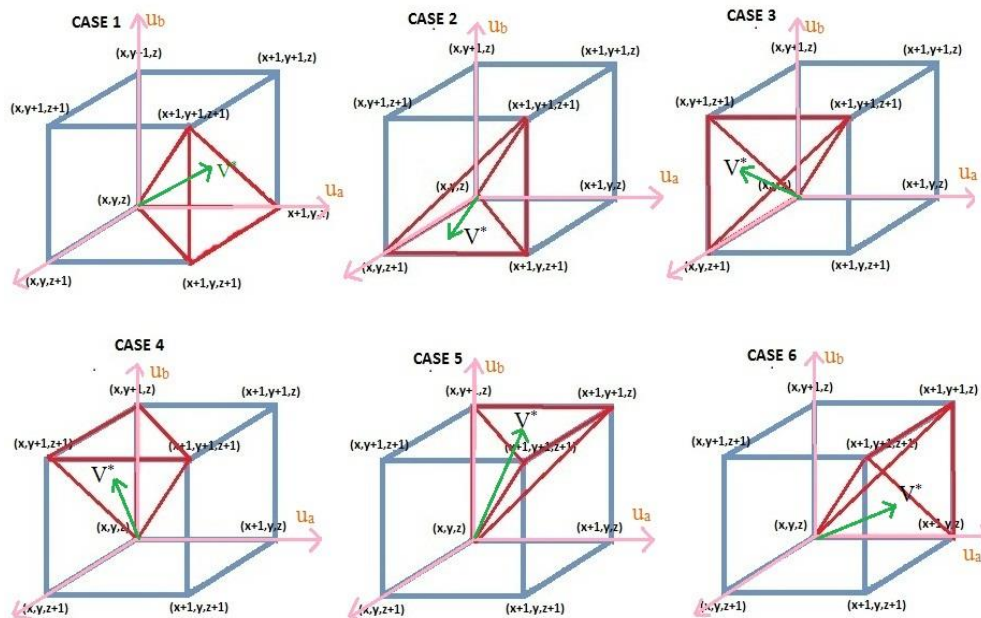

Figure 3. Representation of tetrahedrons in each subcube

Following the discovery of the state vectors that produce each reference vector, the relevant duty cycles are determined. Assume that the reference vector's (a, b, c) coordinates are normalised. The formula for duty cycle is  $d_1+d_2+d_3+d_4=1$ . The major stage entails calculating the four space vectors  $u_1, u_2, u_3,$  and  $u_4$  that correspond to the four vertices of a tetrahedron in the chosen sub cube once (a, b, and c) coordinates

are given. These vectors will produce the necessary reference vector, and Figure 4 (in Appendix) depicts the flow chart for implementing 3D SVM. Calculating the final two vectors,  $u_2$  and  $u_3$ , comes next. These vectors are computed for an optimum switching sequence such that when the inverter changes states, switching only happens in one phase. In order to reduce switching loss, this is done. The calculation is based on the idea that the vector closest to any subcube vertex is swapped first in order to achieve this result. The duty cycle calculations for tetrahedron 1 can be:

$$\begin{aligned} v_{t1a} &= \max(v_{t1}) \\ v_{t1b} &= \min(v_{t1}) \\ v_{t1c} &= \min(v_{t1}) \end{aligned}$$

The reference vector and its integer component are the sole variables that affect duty cycles. In order to reduce the switching number, the optimum switching succession is also chosen. The space vectors are the overturn progression in the second half cycle. The space vectors progression in half cycle are  $(s_a^1, s_b^1, s_c^1), (s_a^2, s_b^2, s_c^2), (s_a^3, s_b^3, s_c^3), (s_a^3, s_b^3, s_c^3)$ .

### 3. SIMULATION RESULTS AND DISCUSSION

The use of a multilayer inverter with a neutral point diode clamp for 3D SVM implementation. From this implementation's provision of the circuit with reference values  $V_a$ ,  $V_b$ , and  $V_c$  to the generation of the appropriate phase voltage values. We determine the subcube identification, tetrahedron identification, and switching time calculations from simulation. Creating the gating pulses for the inverter's switches based on computations of the ON time. Figure 5 illustrates where in a subcube of the complex space plane a reference vector was put.

After determining which subcube's reference vector was put, locate the tetrahedron using those normalised reference vectors. Next, tetrahedron identification to locate reference vectors is shown in Figure 6. Following the identification reference vector, the gating pulses for the switches are then produced utilising this reference vector. In this three-level inverter simulation, three legs are connected, with four switches on each leg for a total of 12 switches. Produced gating pulses are delivered to appropriate switches, and three-level diode clamped multilevel inverters can be controlled using these gating signals.

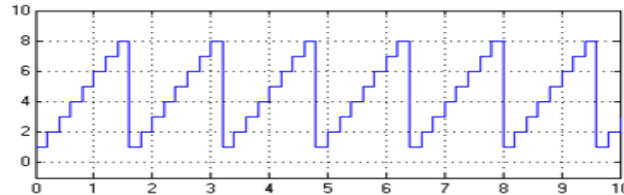

Figure 5. Subcube identification to find reference vector

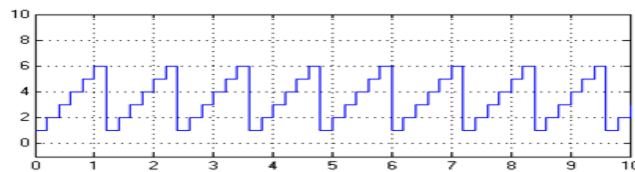

Figure 6. Tetrahedron identification to find reference vector

The Figure 7 shows the gating pulses producing from SVM algorithm. Figure 8 illustrates the generated gating signals that were utilised to control the inverter after it created output phase voltages from a multilayer inverter. Since there is no redundancy in switching states for 3D SVM, each switching state found in the tetrahedron should be easily accessible, allowing the algorithm to produce better gating signals.

Since there are no redundant switching mechanisms in 3D space, output phase voltages and output current should be higher than in 2D SVM. Neither look-up tables nor trigonometric functions are used in this algorithm. It has been successfully incorporated into very affordable micro controllers. This method can be applied as a modulation algorithm in all situations where a 3D control vector is required, such as active filters with four wires and single-phase distorted loads that produce large neutral currents, where the use of conventional two-dimensional space vector modulations is not an option. Figure 9 illustrates the THD analysis for output voltage, which is 0.21%.

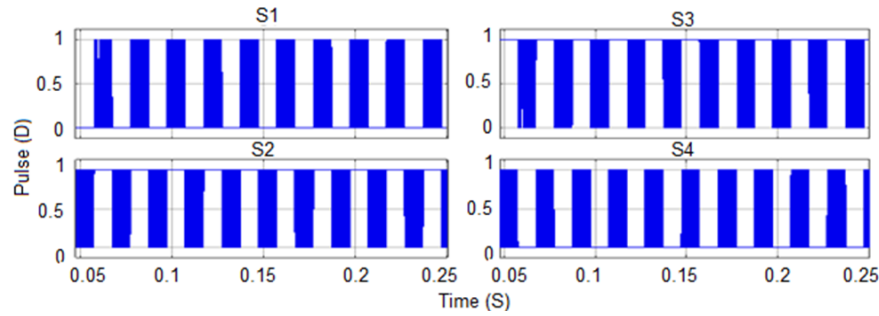

Figure 7. Gating pulses producing from SVM algorithm

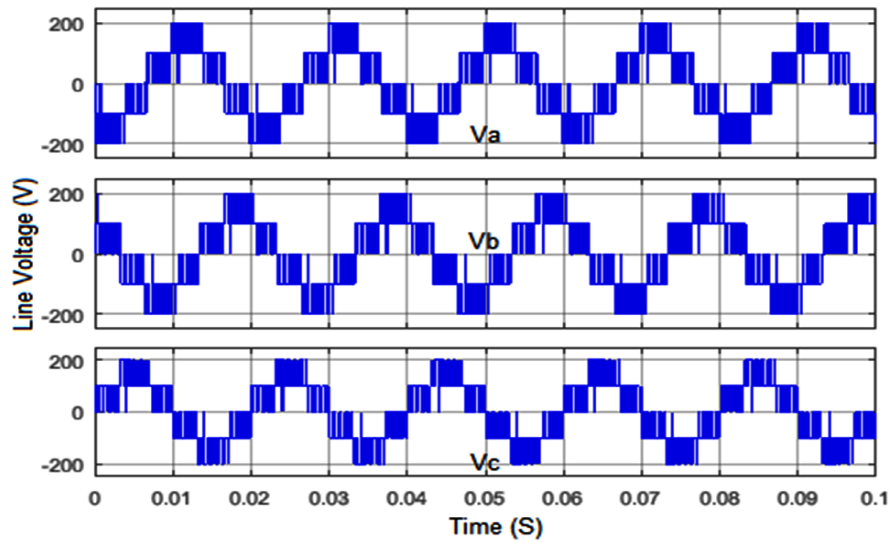

Figure 8. Output phase voltages using SVM

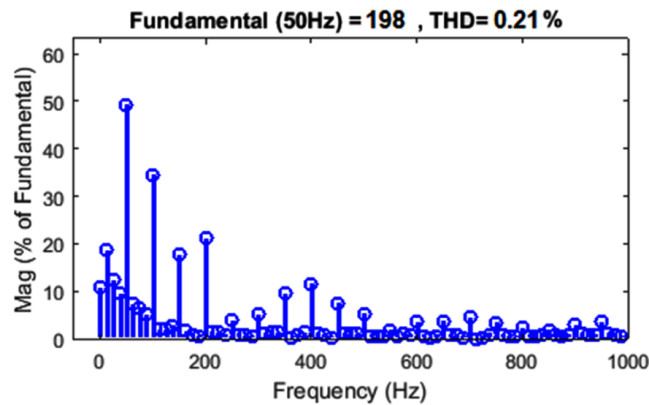

Figure 9. THD analysis for output voltage

#### 4. CONCLUSION

This study describes the simulation of the neutral point clamped multilevel inverter's three-dimensional space vector modulation. The 3D-SVM algorithm is a developed version of the 2D-SVM algorithm; it reduces the complexity of reference vector identification and switching time computation while retaining many of the benefits of 2D-SVM, including reduced EMI problems and overall harmonic distortion that is minimised. This algorithm does not identify the subcube and tetrahedron or calculate the duty cycle using trigonometric functions or look-up tables. Therefore, by using these 3D SVM, it is possible to provide better outputs for neutral point clamped inverters.

APPENDIX

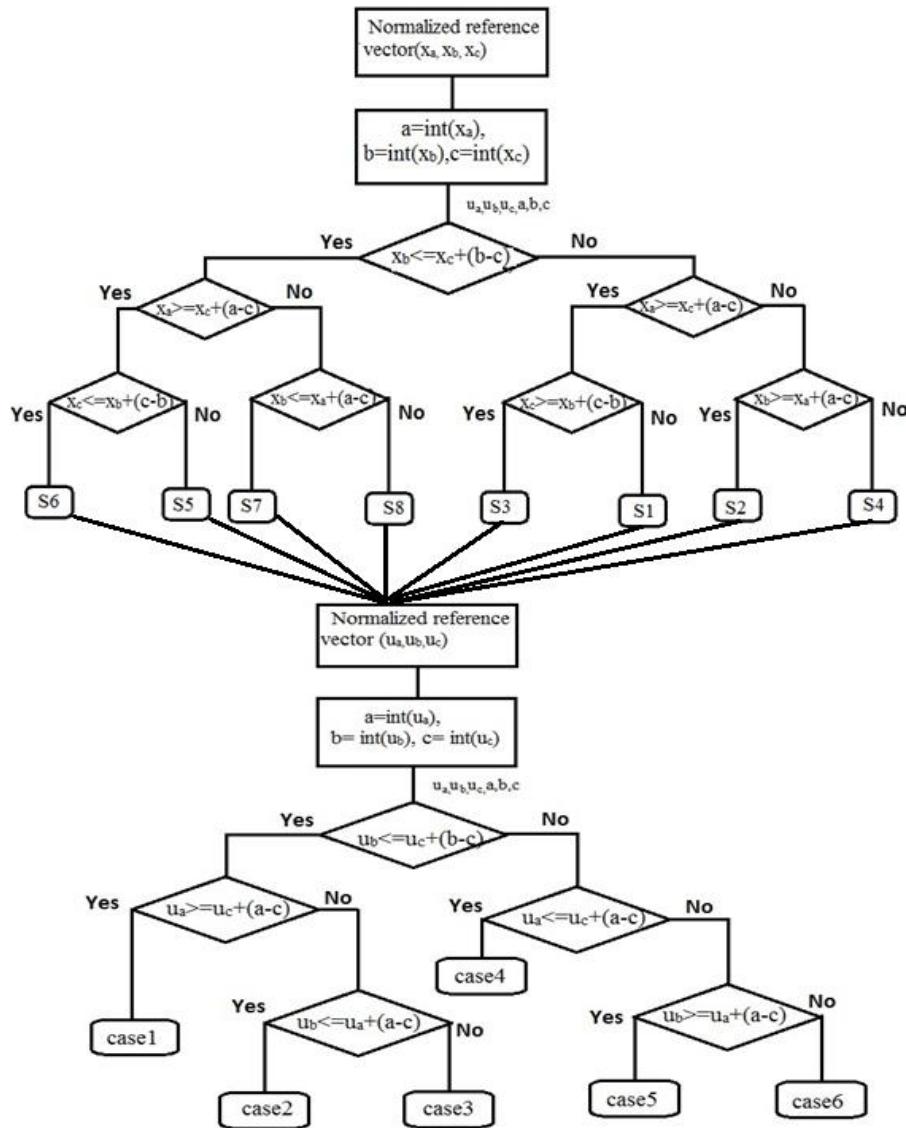

Figure 4. Flow chart for implementation of 3D SVM

REFERENCES



- [1] A. Nabae, I. Takahashi, and H. Akagi, "A New Neutral-Point-Clamped PWM Inverter," *IEEE Transactions on Industry Applications*, vol. IA-17, no. 5, pp. 518–523, Sep. 1981, doi: 10.1109/tia.1981.4503992.
- [2] J. Rodriguez, J.-S. Lai, and F. Z. Peng, "Multilevel inverters: a survey of topologies, controls, and applications," *IEEE Transactions on Industrial Electronics*, vol. 49, no. 4, pp. 724–738, Aug. 2002, doi: 10.1109/tie.2002.801052.
- [3] L. M. Tolbert and T. G. Habetler, "Novel multilevel inverter carrier-based PWM method," *IEEE Transactions on Industry Applications*, vol. 35, no. 5, pp. 1098–1107, 1999, doi: 10.1109/28.793371.
- [4] A. K. Gupta and A. M. Khambadkone, "A Space Vector PWM Scheme for Multilevel Inverters Based on Two-Level Space Vector PWM," *IEEE Transactions on Industrial Electronics*, vol. 53, no. 5, pp. 1631–1639, Oct. 2006, doi: 10.1109/tie.2006.881989.
- [5] M. Á. M. Prats, J. I. L. Galván, R. P. Guisado, J. M. C. Solís, and L. G. Franquelo, "A novel space-vector algorithm for multilevel converters based on geometrical considerations using a new sequence control technique," *Journal of Circuits, Systems and Computers*, vol. 13, no. 04, pp. 845–861, Aug. 2004, doi: 10.1142/s0218126604001647.
- [6] V. T. Ranganathan, "Space vector pulsewidth modulation — A status review," *Sadhana*, vol. 22, no. 6, pp. 675–688, Dec. 1997, doi: 10.1007/bf02745839.
- [7] M. M. Renge and H. M. Suryawanshi, "Three-Dimensional Space-Vector Modulation to Reduce Common-Mode Voltage for Multilevel Inverter," *IEEE Transactions on Industrial Electronics*, vol. 57, no. 7, pp. 2324–2331, Jul. 2010, doi: 10.1109/tie.2009.2027247.
- [8] M. M. Prats, L. G. Franquelo, R. Portillo, J. I. Leon, E. Galvan, and J. M. Carrasco, "A 3-D space vector modulation generalized algorithm for multilevel converters," *IEEE Power Electronics Letters*, vol. 1, no. 4, pp. 110–114, Dec. 2003, doi: 10.1109/lpel.2004.825561.





- [9] N.-Y. Dai, M.-C. Wong, Y.-H. Chen, and Y.-D. Han, "A 3-D Generalized Direct PWM Algorithm for Multilevel Converters," *IEEE Power Electronics Letters*, vol. 3, no. 3, pp. 85–88, Sep. 2005, doi: 10.1109/lpel.2005.855112.
- [10] J. I. Leon *et al.*, "Three-Dimensional Feedforward Space Vector Modulation Applied to Multilevel Diode-Clamped Converters," *IEEE Transactions on Industrial Electronics*, vol. 56, no. 1, pp. 101–109, Jan. 2009, doi: 10.1109/tie.2008.928110.
- [11] K. Hasegawa and H. Akagi, "A new DC-voltage-balancing circuit including a single coupled inductor for a five-level diode-clamped PWM inverter," in *2009 IEEE Energy Conversion Congress and Exposition*, Sep. 2009, doi: 10.1109/ecce.2009.5316393.
- [12] Ó. Lopez, J. Alvarez, J. Doval-Gandoy, and F. D. Freijedo, "Multilevel Multiphase Space Vector PWM Algorithm," *IEEE Transactions on Industrial Electronics*, vol. 55, no. 5, pp. 1933–1942, May 2008, doi: 10.1109/tie.2008.918466.
- [13] N. Celanovic and D. Boroyevich, "A fast space-vector modulation algorithm for multilevel three-phase converters," *IEEE Transactions on Industry I*, vol. 37, no. 2, pp. 637–641, 2001, doi: 10.1109/28.913731.
- [14] S. G. Fernandez, R. Palanisamy, and K. Vijayakumar, "GPS & GSM Based Accident Detection and Auto Intimation," *Indonesian Journal of Electrical Engineering and Computer Science*, vol. 11, no. 1, p. 356, Jul. 2018, doi: 10.11591/ijeecs.v11.i1.pp356-361.
- [15] A. S. A. Mohamed and M. R. Baiju, "A Novel Space Vector PWM Scheme for Multilevel Inverters," in *2009 Twenty-Fourth Annual IEEE Applied Power Electronics Conference and Exposition*, Feb. 2009, doi: 10.1109/apec.2009.4802732.
- [16] S. Wei, B. Wu, F. Li, and C. Liu, "A general space vector PWM control algorithm for multilevel inverters," in *Eighteenth Annual IEEE Applied Power Electronics Conference and Exposition, 2003. APEC '03*, doi: 10.1109/apec.2003.1179268.
- [17] R. Palanisamy, V. Shanmugasundaram, S. Vidyasagar, and K. Vijayakumar, "A Comparative Analysis of Hysteresis Current Control SVM and 3D-SVM for 3-Level NPC Inverter," *Journal of Circuits, Systems and Computers*, vol. 31, no. 02, Sep. 2021, doi: 10.1142/s0218126622300021.
- [18] P. R and K. Vijayakumar, "SVPWM for 3-phase 3-level Neutral Point Clamped Inverter Fed Induction Motor Control," *Indonesian Journal of Electrical Engineering and Computer Science*, vol. 9, no. 3, p. 703, Mar. 2018, doi: 10.11591/ijeecs.v9.i3.pp703-710.
- [19] M. A. Hannan, Z. A. Ghani, M. M. Hoque, P. J. Ker, A. Hussain, and A. Mohamed, "Fuzzy Logic Inverter Controller in Photovoltaic Applications: Issues and Recommendations," *IEEE Access*, vol. 7, pp. 24934–24955, 2019, doi: 10.1109/access.2019.2899610.
- [20] J. I. Leon, R. Portillo, L. G. Franquelo, M. M. Prats, and W. Kolomyjski, "New State Vectors Selection Using Space Vector Modulation in Three Dimensional Control Regions for Multilevel Converters," in *2006 IEEE International Symposium on Industrial Electronics*, Jul. 2006, doi: 10.1109/isie.2006.295673.
- [21] P. Ramasamy and V. Krishnasamy, "Minimization of Common-Mode Voltage of Three-Phase Five-Level NPC Inverter Using 3D Space Vector Modulation," *Journal of Circuits, Systems and Computers*, vol. 29, no. 14, p. 2050229, Mar. 2020, doi: 10.1142/s0218126620502291.
- [22] P. Rodriguez, J. Pou, R. Pindado, J. Montanya, R. Burgos, and D. Boroyevich, "An Alternative Approach on Three-Dimensional Space-Vector Modulation of Three-Phase Inverters," in *2005 IEEE 36th Power Electronics Specialists Conference*, 2005, doi: 10.1109/pesc.2005.1581722.
- [23] L. G. Franquelo *et al.*, "Three-dimensional space-vector modulation algorithm for four-leg multilevel converters using abc coordinates," *IEEE Transactions on Industrial Electronics*, vol. 53, no. 2, pp. 458–466, Apr. 2006, doi: 10.1109/tie.2006.870884.
- [24] P. Ramasamy and V. Krishnasamy, "Minimization of Common-Mode Voltage for Five-Phase Three-Level NPC Inverter Using SVPWM Strategy," *Iranian Journal of Science and Technology, Transactions of Electrical Engineering*, vol. 44, no. 3, pp. 1221–1232, Jan. 2020, doi: 10.1007/s40998-019-00304-5.
- [25] P. Ramasamy, V. Krishnasamy, M. A. J. Sathik, Z. M. Ali, and S. H. E. A. Aleem, "Three-Dimensional Space Vector Modulation Strategy for Capacitor Balancing in Split Inductor Neutral-Point Clamped Multilevel Inverters," *Journal of Circuits, Systems and Computers*, vol. 27, no. 14, p. 1850232, Aug. 2018, doi: 10.1142/s0218126618502328.

## BIOGRAPHIES OF AUTHORS







**Palanisamy Ramasamy**    received the B.E. degree in electrical and electronics engineering from Anna University, India, in 2011, and the M.Tech. degree in power electronics and drives and the Ph.D. degree in power electronics from the SRM Institute of Science and Technology, Chennai, India, in 2013 and 2019, respectively. He is currently working as an Assistant Professor with the Department of Electrical Engineering, SRM Institute of Science and Technology. He has published more than 95 international and national journals. His research interests include power electronics multilevel inverters, various PWM techniques for power converters, FACTS controllers, and grid connected photovoltaic systems. He can be contacted at email: krspalani@gmail.com.







**Ramkumar Ravindran**    is currently working as an Assistant professor in the Department of Electrical and Electronics Engineering at Dhanalakshmi Srinivasan University, Trichy. He obtained his Ph. D under Faculty of Electrical Engineering from Anna University (2022), Chennai. He completed his M.E in Sethu Institute of Technology (2012), Madurai. He completed his BE in K.L.N. College of Information Technology (2008), Madurai. He has published more than 30 Scopus indexed journals and 6 SCI journals in his field. He has 11 years of teaching experience and 1-year industrial experience. His area of interest is power electronic converters, renewable energy and micro grid. He can be contacted at email: 2019ramkr@gmail.com.







**Neetu Gupta**     Assistant Professor, Electronics Engineering Department, J.C. Bose University of Science and Technology, YMCA, Faridabad, has an experience of more than 15 years in teaching. She is currently pursuing her Ph. D degree from the same University. Her doctoral research investigates the use of Bayes Filters for anomaly detection in videos. She takes a multidisciplinary approach that encompasses the fields of artificial intelligence, machine learning, computer vision and pattern recognition. During her course of teaching and research work she has authored and coauthored over 20 research papers in different academic journals and national and international conferences. She holds a master's degree in Communication Systems and a bachelor's degree in Electronics and Communication Engineering from Rajiv Gandhi Proudhyogiki Vishwavidyalaya, Bhopal, Madhya Pradesh. She can be contacted at email: neetu08@gmail.com.







**Gunjan Sardana**     Assistant Professor, Electronics Engineering Department, J.C. Bose University of Science and Technology, YMCA, Faridabad, has an experience of 15 years in teaching. She has authored and coauthored over 10 research papers in different academic journals and national and international conferences. She holds a master's degree in Electronics and Communication and a Bachelor's degree in Electronics and Communication Engineering from N.C. College of Engineering, Kurukshetra University, Haryana. She can be contacted at email: gunjansardana83@gmail.com.







**Indumathi Sekar**     Assistant Professor, Electronics and Communication Engineering Department, R.M.D. Engineering College, Thiruvallur District, Tamil Nadu, India. She has more than 2 years of experience in teaching. She has received M.E degree in Applied Electronics from SSN College of Engineering, Chennai. Her research interests include antenna design (UWB antenna, MIMO antenna and reflectarray antenna) VLSI design and verification (system verilog and UVM). She can be contacted at email: indumathisekar1993@gmail.com.



**Venugopala Aparna Marthanda**     currently working as an Associate professor with LakiReddy Balireddy College of Engineering, Mylavaram (LBRCE) permanently affiliated to JNTU Kakinada, Krishna District, Andhra Pradesh. He was Graduated in Electrical and Electronic Engineering (EEE) from (GITAM) affiliated to Andhra University Vishakhapatnam, India. He secured his Master of Technology in Energy Management from Sri Venkateswara University, Tirupathi, India. He secured his Doctral Ph.D in EEE from Sri Venkateswara University, Tirupathi, India. Having both academic (17 years) and Industrial experience (12 years). Holding research publications and patents in same domain. Guided many UG and PG students. His area of interest is to conserve energy in different sectors by implementing recent advanced methods. He can be contacted at email: myenergysai4u@gmail.com.



**Selvakumar Kuppusamy**     received B.E degree in Electrical and Electronics Engineering, M.E degree in Power System Engineering both from Anna University and received P.hD in Deregulated Power systems from SRM University, Kattankulathur, Tamilnadu, India in 2018. He is currently working as an Assistant Professor in SRM University. His research interests include unit commitment, economic dispatch, power system optimization and smart grid, distributed generation in power system. He can be contacted at email: selvakse@gmail.com.