

# Mitigation of Lightning Hazards at the More Sensitive Points in Wind Farms Using Ant-Colony Optimization Technique

MA Abd-Allah\*, A Said, Mahmoud N Ali

Faculty of Engineering at Shoubra, Benha University, Egypt

\*Corresponding author, e-mail: abdelrahman.ghoniem@feng.bu.edu.eg

## Abstract

The lightning energy can be very harmful to the wind turbine farm components. This paper attempts to evaluate the overvoltages at the sensitive points in wind farm, using ATP-EMTP package program. Four cases were performed; a) the transient voltage distribution in the insulating layer of the control line, b) the transient voltage on the control equipment, c) the coupling voltage between the tower and the control, and, d) the transient voltage distribution in the wind turbine WT generator, boost transformers and grid. These cases were performed under different lightning current conditions and at conventional design and proper design of grounding system. The results show that the ground potential rise (GPR) is reduced with using the proper design of wind turbine ground system, but the induced voltage at the control system will not be affected. This work determines the optimum location of wind turbine at the areas of maximum lightning incidence. Ant colony optimization (ACO) technique is implemented to find the optimum wind farm location. This work enhances the protection strategy of the wind farms against lightning stroke.

**Keywords:** Overvoltages, GPR, Capacitive coupling, ATP-EMTP, WT Generator, ACO

## 1. Introduction.

When wind turbines are attacked by lightning, a harmful induced voltage can be generated on wind turbine blade, tower, conductors of internal control cable, and shielding layer of cables [1, 2, 3, 4]. The method and path of induced voltage generation can be classified as; the inductive induced voltage and the capacitive induced voltage. However, another serious problem known as "back-flow surge" is happened, which can cause damages not only to the struck wind turbine, but also the other turbines. The back-flow surge phenomenon has been defined as the surge flowing from a customer's structure such as a communication tower into the distribution line. High resistivity soil often increases the GPR and at the same time the Surge Arresters (SAs), at tower earthing systems, operate in reverse direction and conduct backflow current to the grid. The phenomenon of surge invasion from a wind turbine that is struck by lightning to the distribution line in a wind farm is quite similar to the case of "back-flow surge" [2]. In this paper capacitive induced voltage and GPR will be simulated and analyzed. From the simulation results, characteristics and hazards of back-flow surge, GPR, and capacitive induced voltages in wind farm are analyzed using onshore wind farm as an example. The transient voltage distribution in the insulating layer of the control line, the transient voltage on the control equipment, the coupling voltage between the tower and the control, and the transient voltage distribution in the WT Generator, Boost transformers and grid, were performed under different lightning currents (51 kA (8/20  $\mu$ s) and 51 kA (2/631  $\mu$ s), both at conventional design and proper design of grounding system. The impacts of GPR on generators insulation, boost transformer insulation and grid will be analyzed. The impact of capacitive induced voltages on the wind turbine system, i.e. insulation of shielding control cables, electrical control device, de-icing systems will be investigated. The impact of induced voltage inside tower and probability of electrical breakdown will be presented. The impact of surge voltage on the insulation on both ends of control line will be investigated. Ant Colony Optimization (ACO) technique is implemented to find the optimum wind farm location.

## 2. Description of the Onshore Wind Farm under Study

The layout of onshore wind farm composed of two identical wind power generators is shown in Figure 1. Boost transformers for the generators are installed in vicinity of the wind turbine towers. All boost transformers are connected to the grid via grid-interactive transformer by overhead distribution line. Surge arresters are inserted to the primary and secondary sides of the boost and grid-interactive transformers.

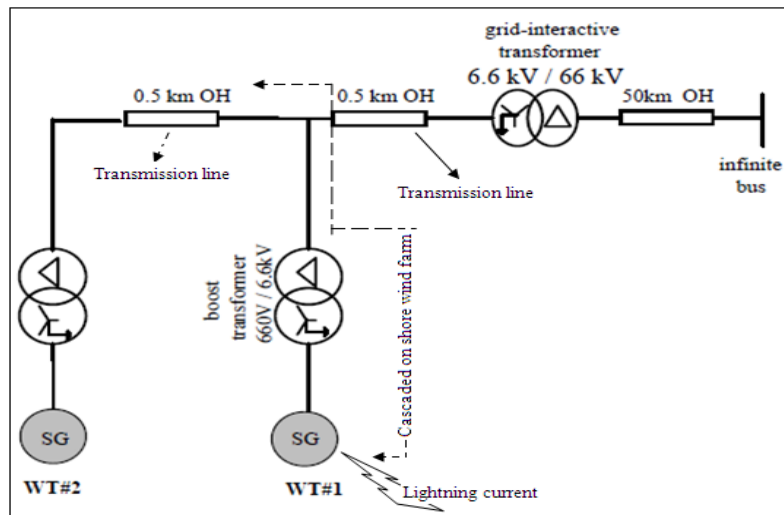

Figure 1. Wind farm single line diagram and detailed model of lightning struck turbine [2]





## 3. Modeling of Onshore Wind Farm Components Using ATP/EMTP

In this section, the detailed high frequency modeling of the electric components of the onshore wind farm using the ATP/EMTP is demonstrated. These components include Tower, Control systems, Transmission line (TL), transformers, power system grid and surge arresters. Table 1 shows the different components and their simulation circuits.

Frequency dependent transformer model and frequency dependent model of Surge arrester (SA) is a combination of non linear elements and linear inductances which provides dynamic behavior during lightning and tower including control systems [8]. The SAs are used at low, medium and high voltage levels in the wind farm as shown in Figure 2.

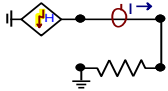
Figure 3 shows detailed  $\pi$ - lumped equivalent circuit wind turbine model including the internal controlling used in this study. The wind turbine was the 3 part 60 m Vestas V47-690/200 kW found in zafarana wind farm, Egypt [4], and the tower-control line model was built according to the tower structure of the wind turbine. When the tower of the wind turbine struck directly by a lightning stroke, the control line inside the tower is simulated by its equivalent inductance, the insulation of the control wire is simulated by its equivalent capacitance and the air insulation between control line and the internal surface of the tower is simulated by its equivalent capacitance. Where C01~C010 are grounding capacities of tower, C12 is the capacitive coupling path between tower and shielding layer of cable, C23 is the capacitive coupling path between shielding layer of cable and inner conductor, z1, z2, and z3 are the impedance of tower, impedance of shielding layer of cable, and the impedance of cable conductor [4].

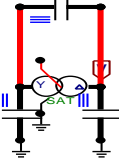
Table 1. Different component of wind farm and simulation circuits

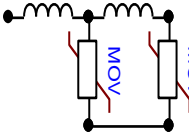
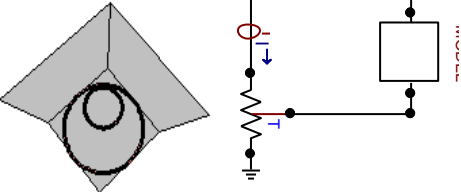
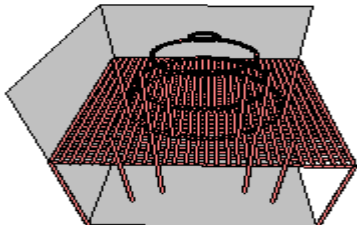
Component	Simulation shape	Data used
Lightning current		51kA-2/631μs winter lightning in japans [2]
Synchronous Generator- Y connected		Voltage (line rms) 0.660 [kV] Rated power 1.0 [MVA] Leakage reactance 0.1 [H] Frequency 60.0 [Hz]
Transformer (Boost, Grid-Interactive)		Connection method Y / Δ, Y / Δ Voltage (line rms) 0.660/6.6 [kV], 66.0/6.6 [kV] Rated power 1.0 [MVA], 10.0 [MVA]
Line		Positive / zero phase inductance [mH/Km] 0.83556/2.50067 Positive / zero phase capacitance [nF/Km] 12.9445/6.4723
Surge arresters		440kV SA with L <sub>1</sub> and L <sub>0</sub> are equal 0.07μH [5,6]
Conventional grounding system		Ring only#12 Diameted at 1 meter depth [7]
Proposed grounding system		12 rods in this design and three rings with radius of 6m, 8m and 10m respectively and foundation from steal conductor constructed in an area of 15*15m [7].

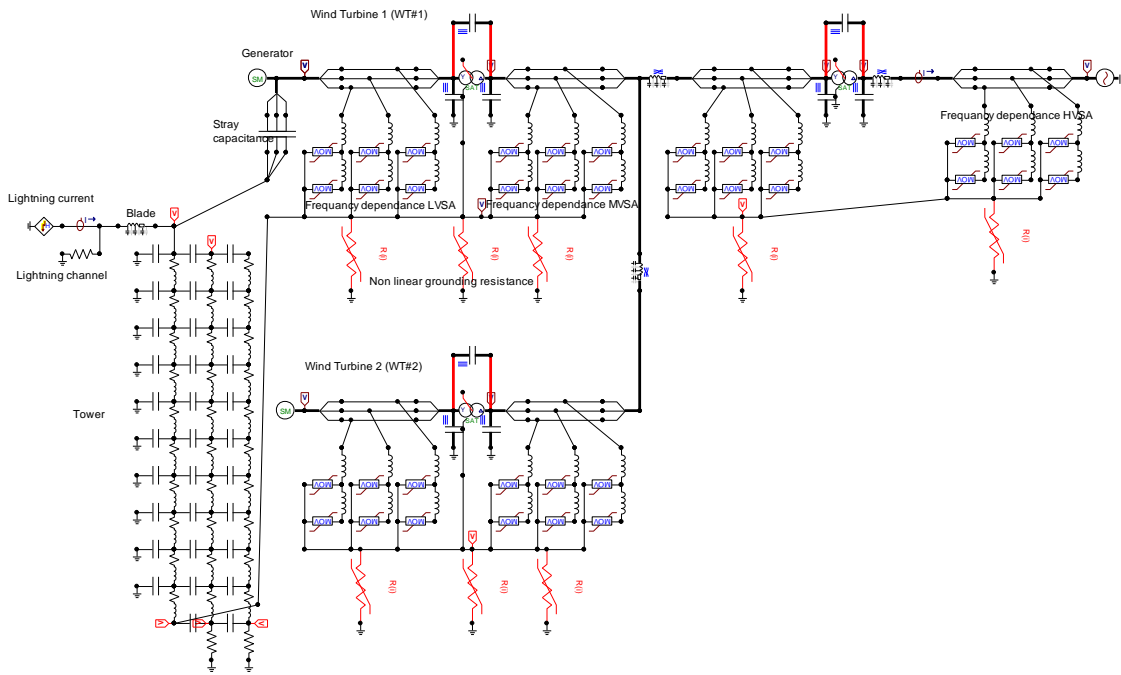

Figure 2. ATPDraw circuit of two wind turbines with frequency dependant model

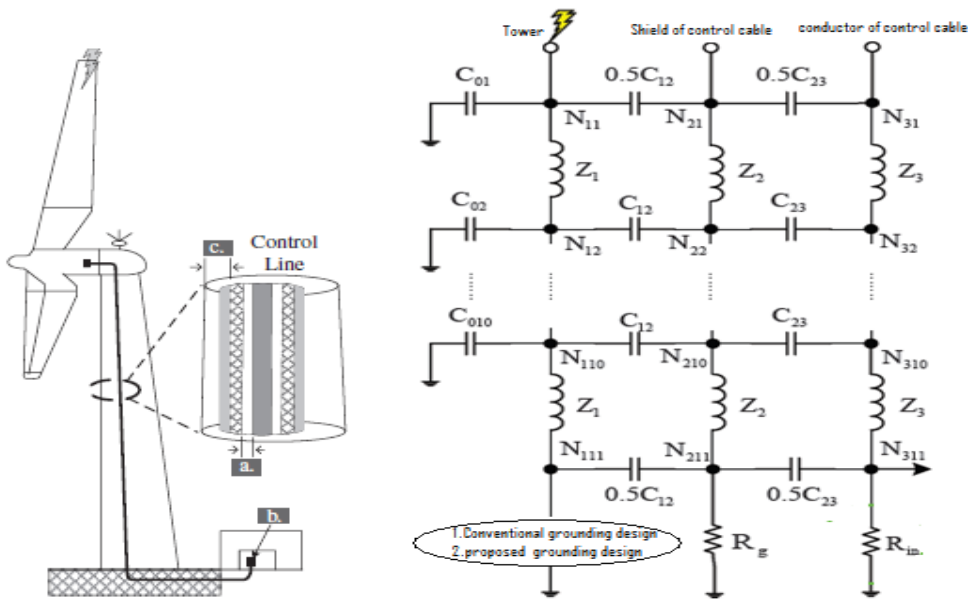

Figure 3. Electromagnetic induction model of the internal controlling of wind turbine

#### 4. Lightning Hazards at Sensitive Points in Wind Farm

To estimate the hazards of the lightning strokes on the wind farm sensitive components; four locations are taken into considerations as the more sensitive locations; namely:

- a) The transient voltage distribution in the insulating layer of the control line,
- b) The transient voltage on the control equipment,
- c) and the coupling voltage between the tower and the control

- d) The transient voltage distribution in the WT Generator, Boost transformers and the grid. These cases were performed under the following conditions.
  - i. Lightning current: 51 kA (8/20  $\mu$ s), 51 kA (2/631  $\mu$ s)
  - ii. Grounding design: Conventional design and proper design,

**4.1. Transient Voltage Distribution in the Insulating Layer of Control Line**

The voltage distribution in the insulating layer of each segment of the control line from the top to the bottom for each insulating layer VN2i ~ N3i (i=1 ~ 11) estimated. Figures 4 and 5 show the transient voltage (VN211\_N311) waveforms in the insulating layer of the bottom control line under various lightning currents and grounding design. The results show that the transient voltage phenomena in the insulating layer of the control line for different ground systems are similar. Under various lightning currents, the maximum transient voltages are 25 kV and 2.5 MV, respectively.

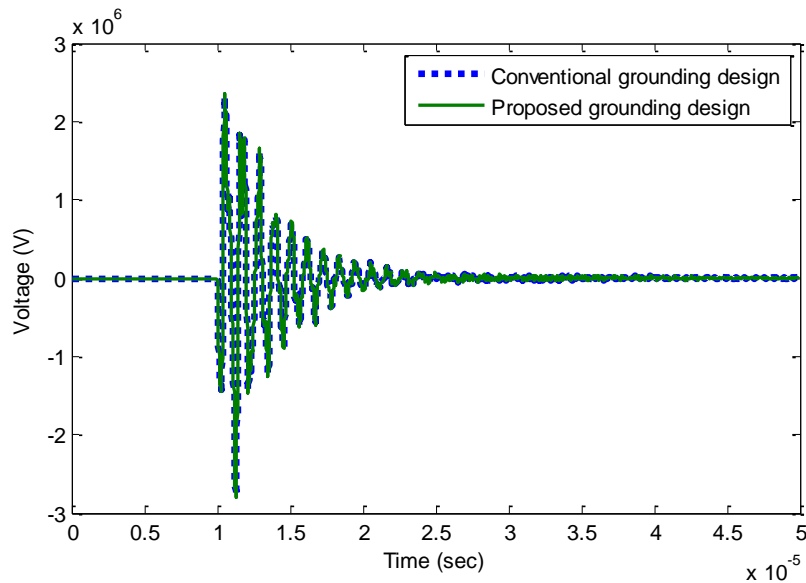

Figure 4. Insulation layer voltage under only 51kA 8/20 $\mu$ s

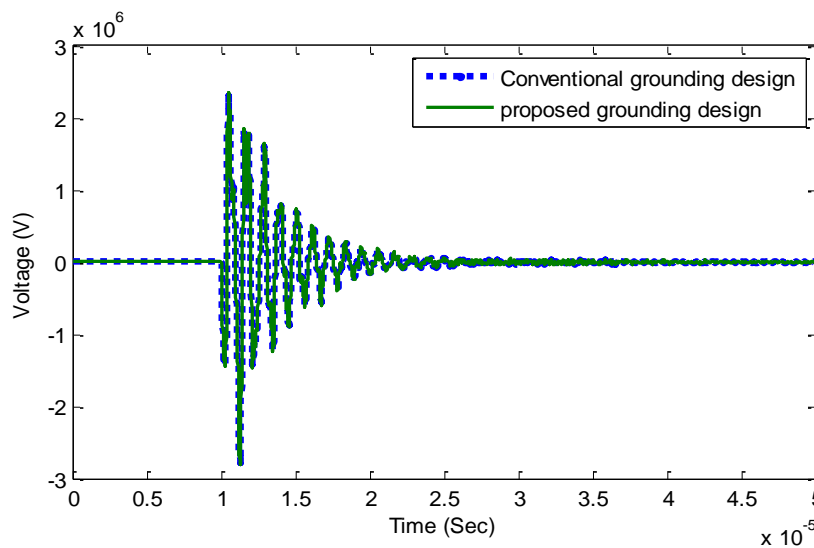

Figure 5. Insulation layer voltage under only 51kA 2/631 $\mu$ s

Figure 6 shows the induced voltage on the insulation layer at top, bottom and center of tower; under proposed grounding design and different lightning current. The maximum insulation withstand voltage is 66 kV [4], whereas the insulating layer thickness of the control cable is 1.1 mm. The figure shows also that, the transient voltage at the top and bottom of the control cable is higher than that at the middle length of the control cable. According to the results, the higher tail time lightning wave resulted in greater transient voltages. The insulating layer of the control line will be breakdown with lightning current of long tail time.

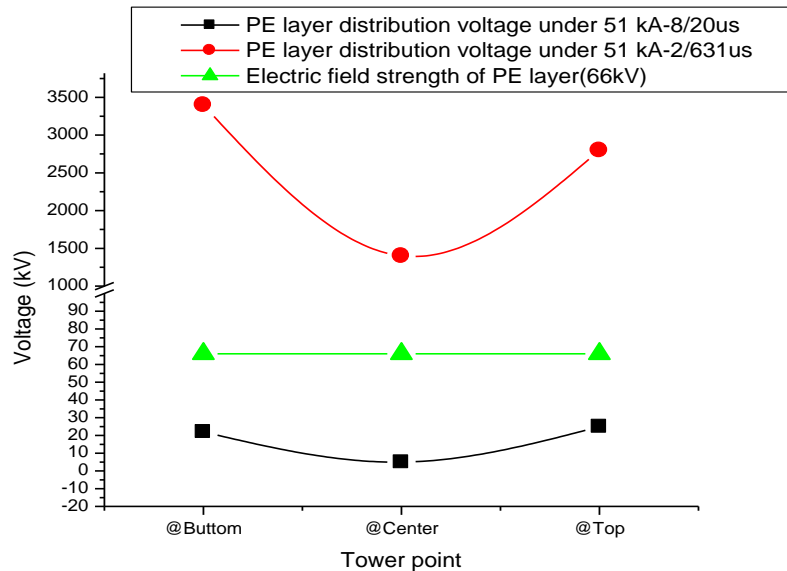

Figure 6. Insulation layer voltages under proposed grounding design and different lightning current

#### 4.2. Transient Voltage on the Control Equipment

This case demonstrated the effects of transient voltage (VN311) on the control equipment when a tower struck by different lightning current. Figures 7 and 8 show the waveforms of transient voltage (VN311) on the control equipment under various lightning currents and grounding design.

The results show that the ground design has no effect on the magnitudes of over voltage at control device under the same lightning current. When the lightning current was 51 kA (2/631  $\mu$ s), the influence was more severe; whereas overvoltage reach to 3MV.

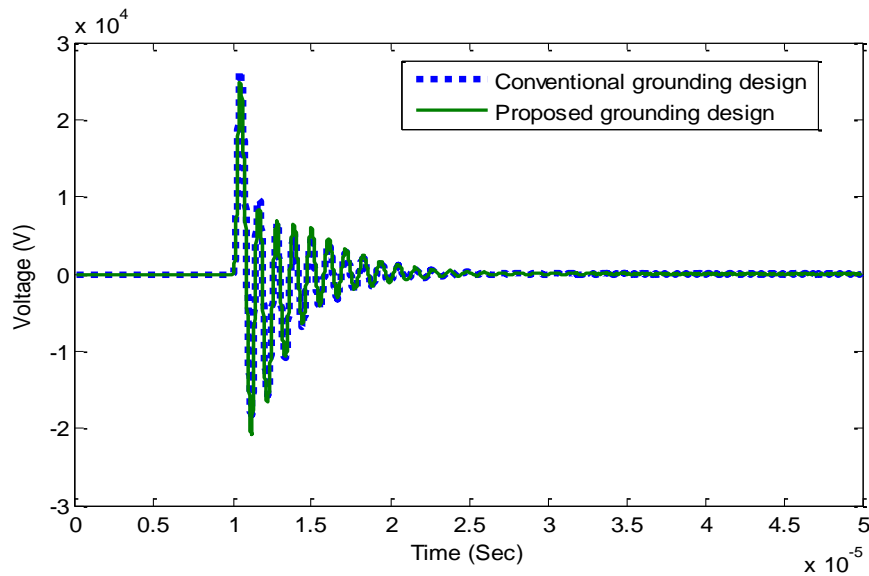

Figure 7. Control device voltage under only 51kA 8/20µs

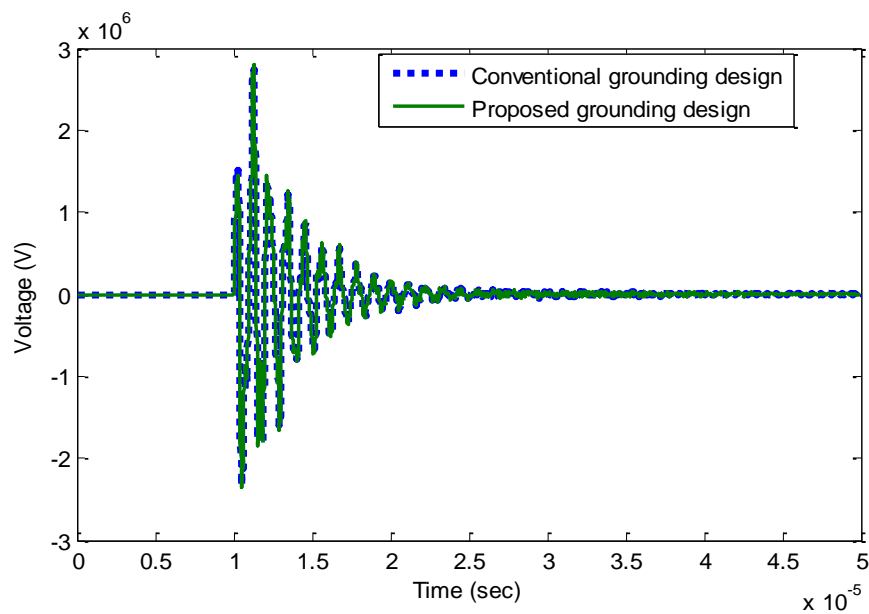

Figure 8. Control device voltage under only 51kA 2/631µs

**4.3. Induced Voltage on the Tower**

This section is aimed at assessing the induced transient voltage (VN1-N21) at the top of the tower, coupled with the control line through stray capacitance, when the tower is directly struck by lightning stroke.

Figures 9 and 10 show the induced coupling voltage at the top of the tower. The results show that, when the conventional ground design used, the induced coupling voltage is greater than that with the proposed grounding design. However, when the lightning current is 51 kA (8/20 µs), the coupling voltage can be as high as 3000 kV. When the lightning current was 51 kA (2/631 µs), the coupling voltage can be as high as 15000 kV. To protect wind turbines from damages under 51 kA (8/20 µs) lightning the distance between the tower and the shielding layer should be 100 cm and under 51 kA (2/631 µs) should be 500 cm but this not practical.

Therefore, an appropriate distance between the tower and the control line should be maintained.

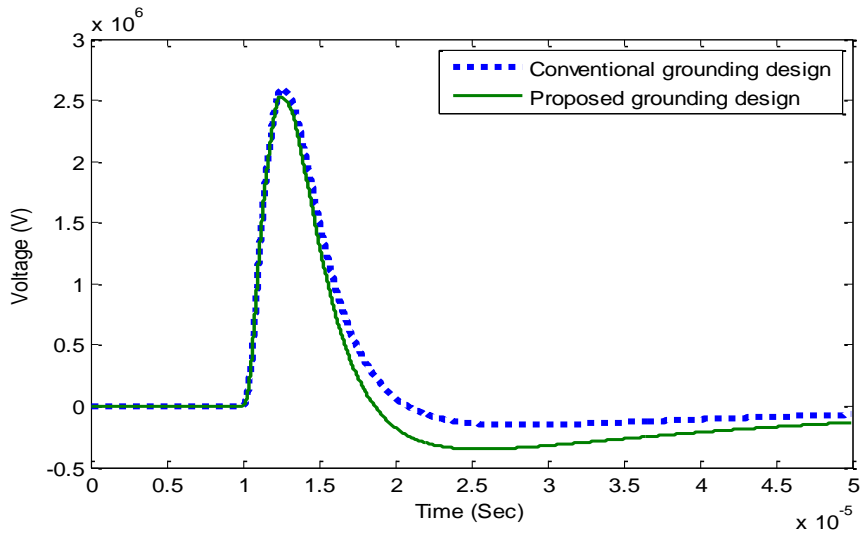

Figure 9. Tower top voltage under only 51kA 8/20µs

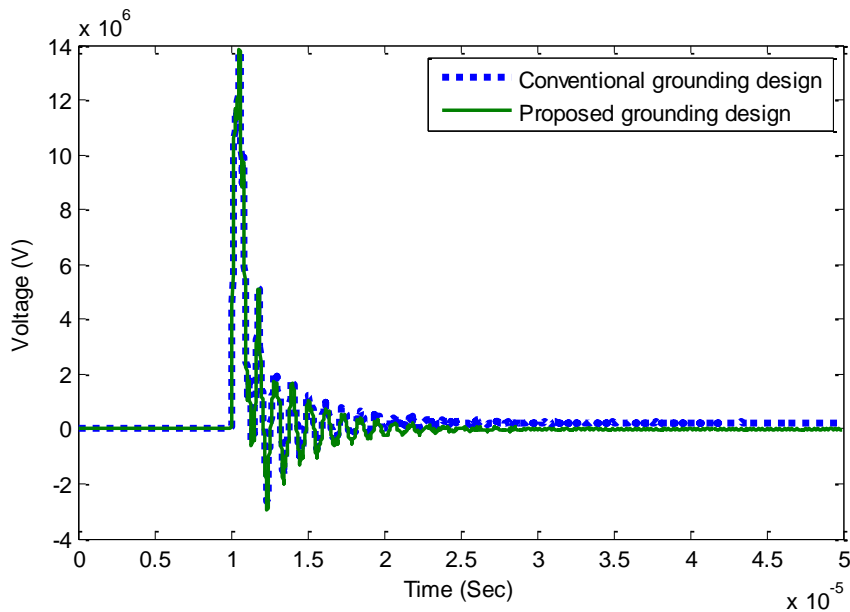
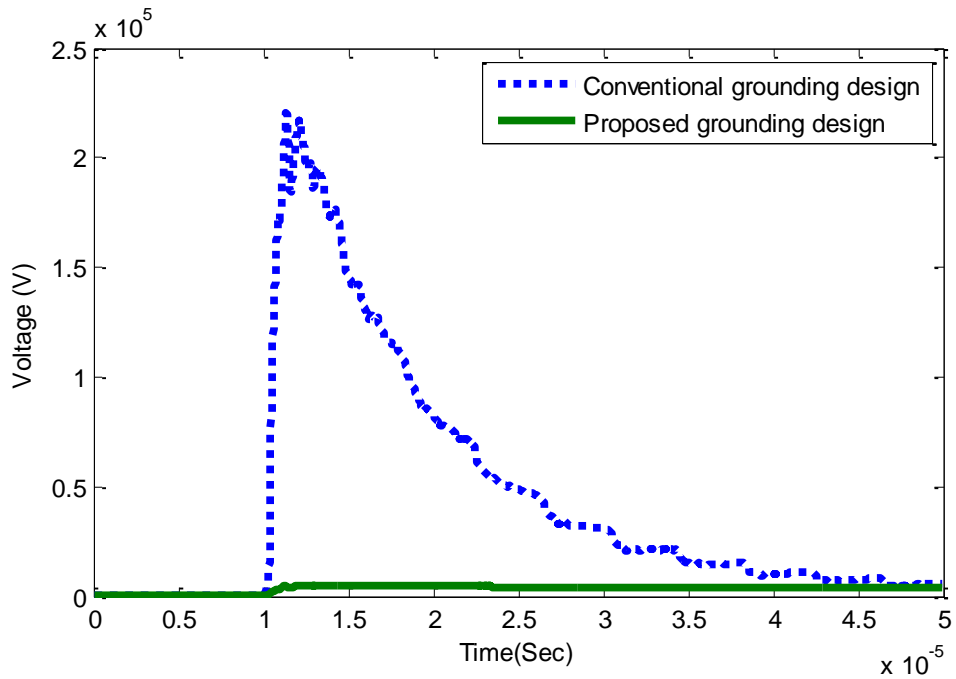

Figure 10. Tower top voltage under only 51kA 2/631µs

**4.4. Transient Voltage Distribution in WT Generator and Boost Transformers**

Figure 11 shows the induced voltage at generator terminal, secondary side of boost transformer, GPR at turbine struck by the lightning stroke, and grid when using grounding system including ring electrode only and our proposed design. The results show that the overvoltage reduced by about 95% and GPR decrease by about 97% when using proposed design of grounding system. This can attributes to the fact that, the proposed grounding grid covers large area of ground.





a. Voltage waveforms Comparison at generator terminal of WT#1

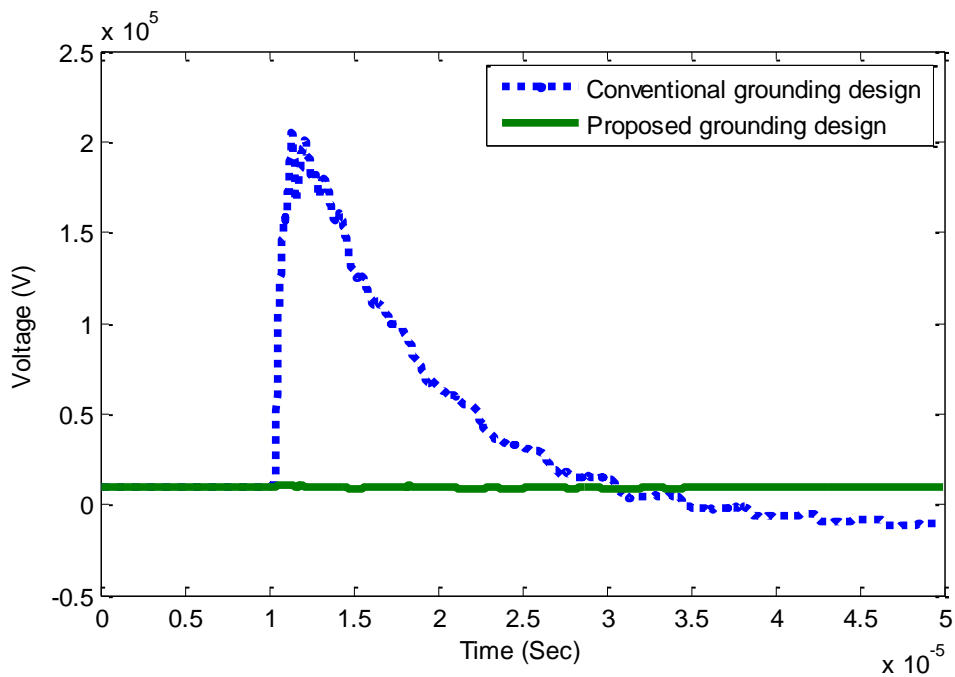

b. Voltage waveforms Comparison at boost transformer of WT#1

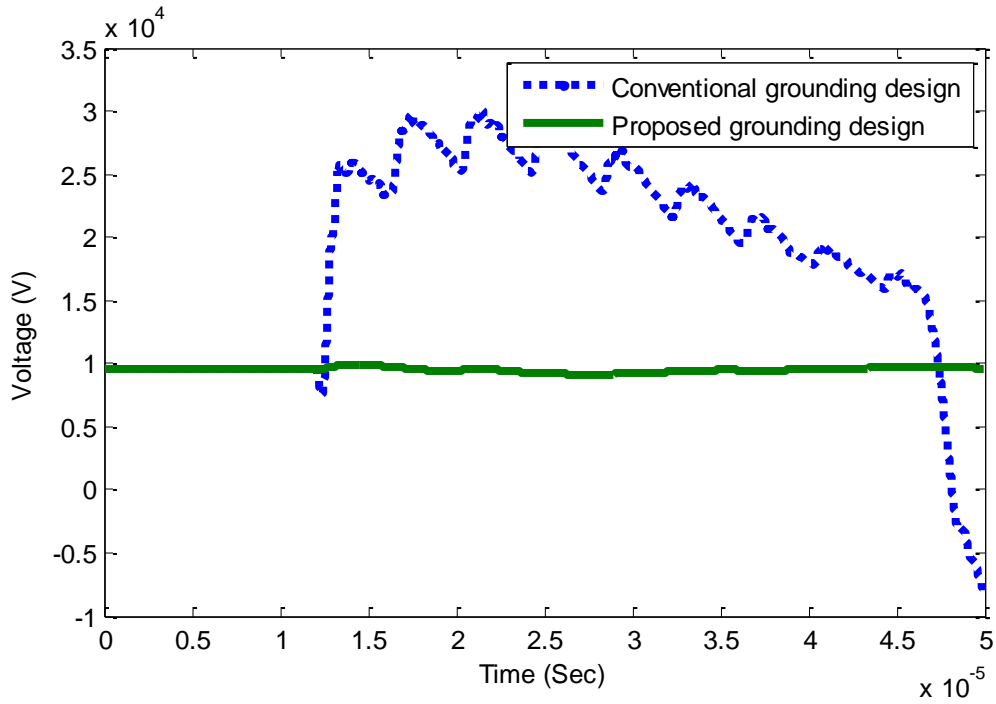

c. Voltage waveforms Comparison at Grid

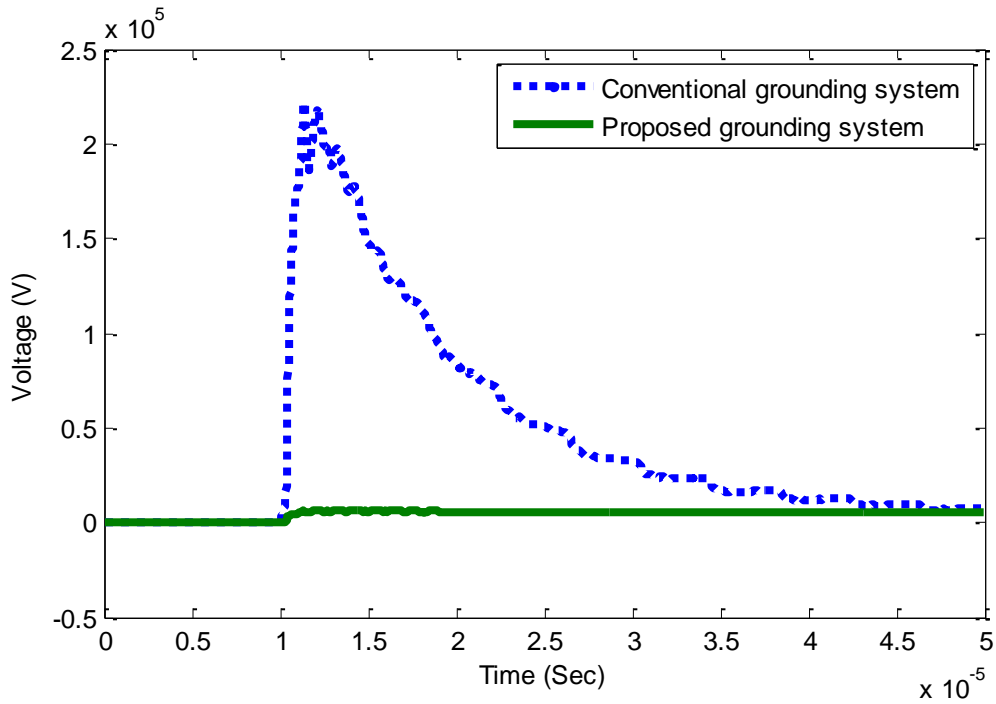

d. GPR waveforms Comparison at WT#1

Figure 11. Overvoltages, GPR at turbine struck by lightning and grid under different grounding arrangements

### 5. Mitigation of Lightning Hazards Using Ant Colony Optimization Technique

From previous results The GPR is reduced by a proper design of wind turbine ground system but induced voltage in control system not affected so this paper introduced to identify optimum new location of wind turbine distant from the areas with maximum lightning incidence. Ant Colony Optimization (ACO) technique is implemented to find the optimum wind farm location. This paper can increase the capital on the protection from lightning in that area.

The ant colony optimization algorithm (ACO) is a probabilistic technique for solving computational problems which can be reduced for finding good paths through graphs. This algorithm is a member of the ant colony algorithms family, in swarm intelligence methods, and it constitutes some metaheuristic optimizations. It is initially proposed by Marco Dorigo in 1992 in his PhD thesis [9]. The first algorithm was aiming to search for an optimal path in a graph, based on the behavior of ants seeking a path between their colony and a source of food. In the natural world, ants (initially) wander randomly, and upon finding food return to their colony while laying down pheromone trails. If other ants find such a path, they are likely not to keep travelling at random, but to instead follow the trail, returning and reinforcing it if they eventually find food. Over time, however, the pheromone trail starts to evaporate, thus reducing its attractive strength. The more time it takes for an ant to travel down the path and back again, the more time the pheromones have to evaporate. A short path, by comparison, gets marched over more frequently, and thus the pheromone density becomes higher on shorter paths than longer ones [10]. Figure 12 illustrates the behavior of real ants in searching the source of food [11].

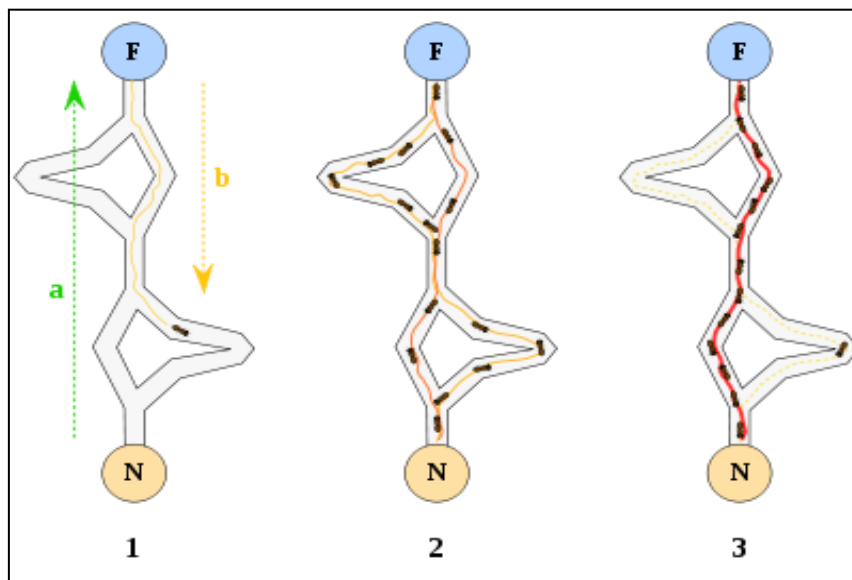

Figure 12. Ants from nest to the source of food

The algorithm of ACO is build according to equations (1) and (2), where:  $P$  is the probability,  $\alpha$ ,  $\beta$ ,  $\tau$  are parameters related to ACO algorithm,  $d$  is the distance,  $Q$  being a constant parameter,  $L_k$  is the  $k$ th ant solution,  $\rho$  is a parameter used to avoid unlimited accumulation of the pheromone trails and  $m$  is the number of ants.

The first equation describes the probability of the ant to move between the two nodes  $i$  and  $j$ , while the second one describes the local updating of pheromone after travelling from a node to another one.

$$p_{ij}(t) = \frac{\tau_{ij}(t)^\alpha \left(\frac{1}{d_{ij}}\right)^\beta}{\sum_{j \in \text{nodes}} \tau_{ij}(t)^\alpha \left(\frac{1}{d_{ij}}\right)^\beta} \quad (1)$$

$$\tau_{ij}(t+1) = (1-\rho)\tau_{ij}(t) + \sum_{\substack{k \in \text{colony that} \\ \text{used edge} \\ (i,j)}} \frac{Q}{L_m} \quad (2)$$

Advantages of ACO technique can be represented as:

- Positive Feedback accounts for rapid discovery of good solutions
- Distributed computation avoids premature convergence.
- The greedy heuristic helps finding acceptable solution in the early solution in the early stages of the search process.

While disadvantages of ACO technique can be represented as:

- Lower convergence than other Heuristics.
- Performs poorly for problems have larger than 75 nodes.
- No centralized processor to guide the ACO towards good solutions [12].

In this paper ACO algorithm is used to find the optimum wind farm location.

## 5.2. Problem Definition

Even when the lightning strikes the ground, the generated electromagnetic waves can cause problems to communication lines and electronic circuits. Figure 13 shows lightning strike is at a distance  $D$  from the pair of wires at distance  $w$  from each other forming the loop with area  $A=a*b$ . The flux changes in the area  $A$  because of different distances from the lightning current. The integral is taken on defining voltage induced in loop  $A$ . It is assumed that loop  $A$  is perpendicular to the magnetic field of the lightning current. The objective function is to minimize the voltage induced in this loop. Voltage is a function of the rate of change of lightning current and distance from the stroke site. The voltage induced in loop  $A$  decreases with the increase of the distance; equation (3).

$$U = \frac{\mu_0}{2\pi} * I * \ln\left(\frac{d+w}{d}\right) * \frac{di}{dt} = M * \frac{di}{dt} \quad (3)$$

Where

$\mu_0$  : the absolute magnetic inductivity  $4\pi \times 10^{-7}(\text{H/m})$

$M$  : mutual inductance in the loop

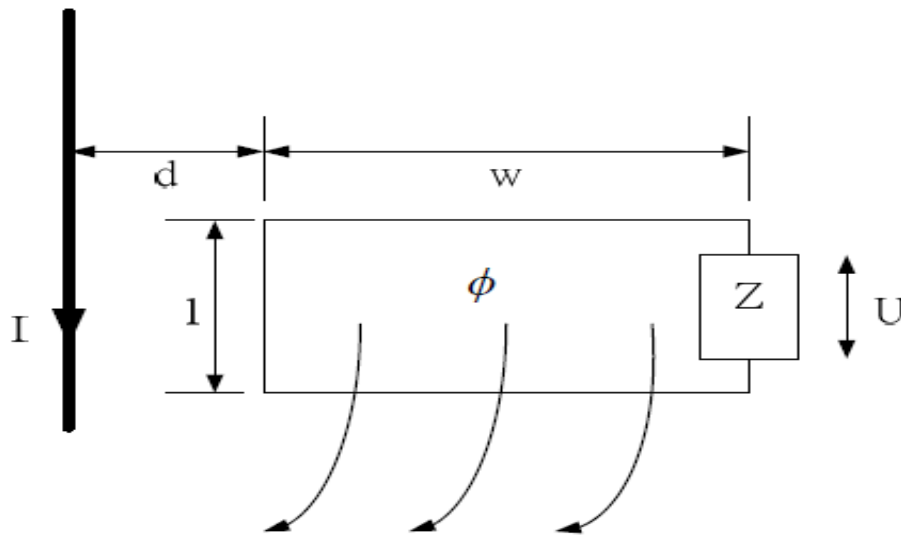

Figure 13. Voltage induced in a loop due to lightning current [2]

**5.3. Optimum Location of Wind Farm**

It is assumed that the area of interest is 1000 x 1000 units of length, the lightning direction of propagation is vertical, the wind farm location is much smaller than the area in study, and the lightning strikes are occurring in a grid 100 x 100 as shown in Figure 14. As a restriction, it is supposed that the wind turbines are required to be located in the inner area, from 100 to 900 in both axes.

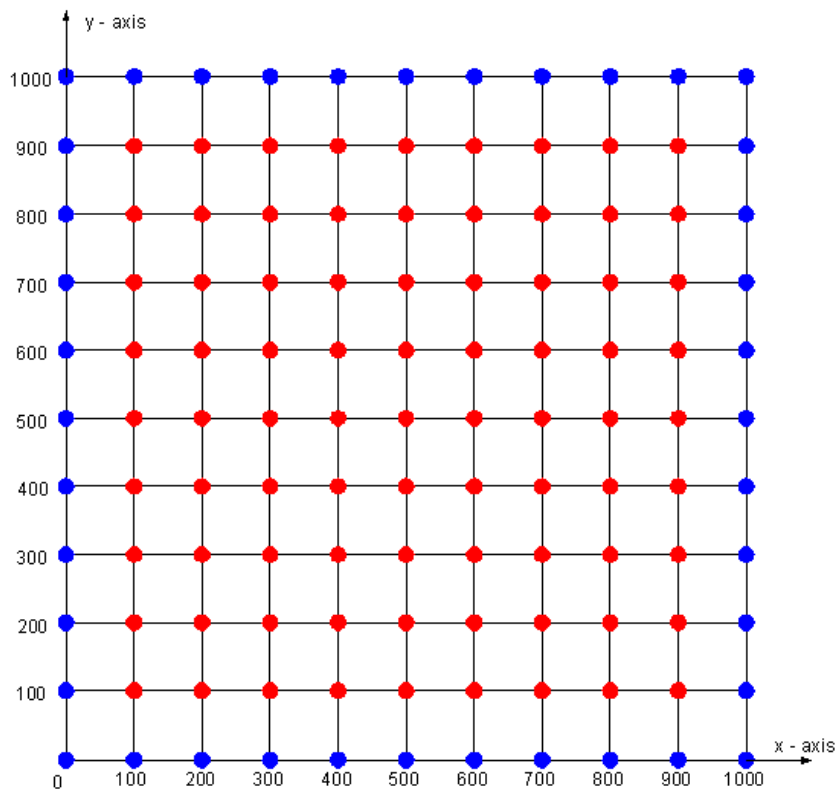

Figure 14. Simulation area

A flowchart for this optimization process is shown in Figure 15.

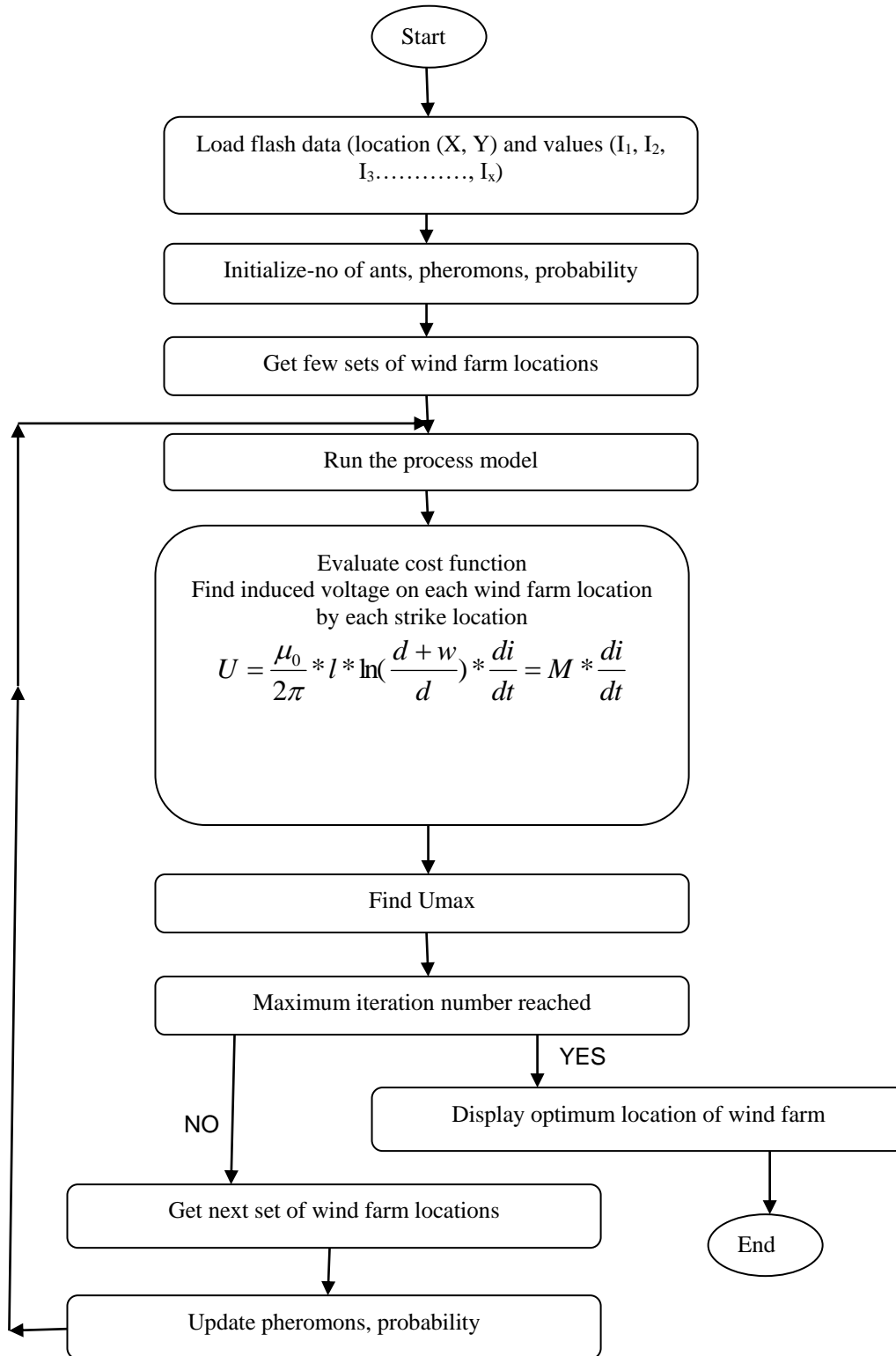

Figure 15. Voltage induced algorithm flow chart

The distance as well as the rate of change of lightning current is considered to determine the best location of minimum interference with lightning transients. The distribution of rate of change of current is random through the strike sites. Figure 16 and Figure 17 represent the simulation of ten random distributed strike locations in the area under study. The rate of change of lightning current is Gaussian distributed with mean 25 000 A/s and two standard deviations [13]. The best wind farm location is found at the site with distance from the stroke locations (876, 484). The algorithm takes into account the amount of rate of change of lightning current for stroke locations. The best function value is plotted as 0.001. It took 100 out of 1000 alterations for the objective function to converge.

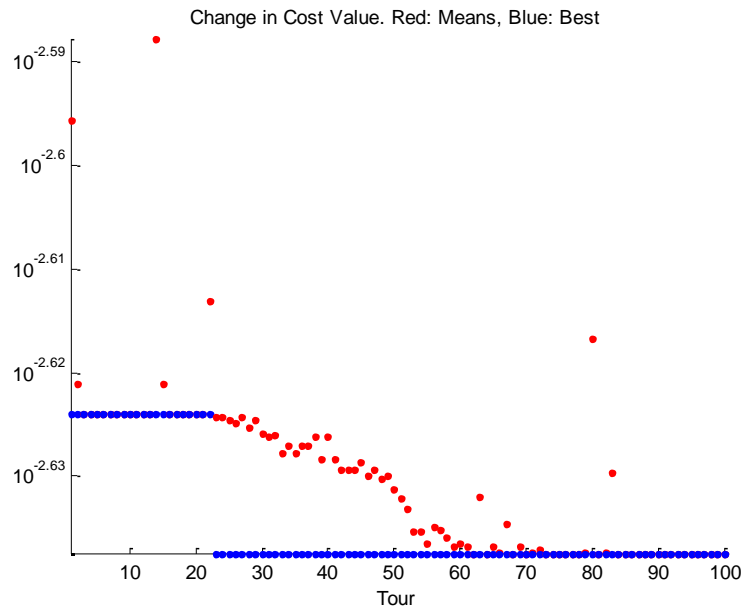

Figure 16. Mean and Best Fitness

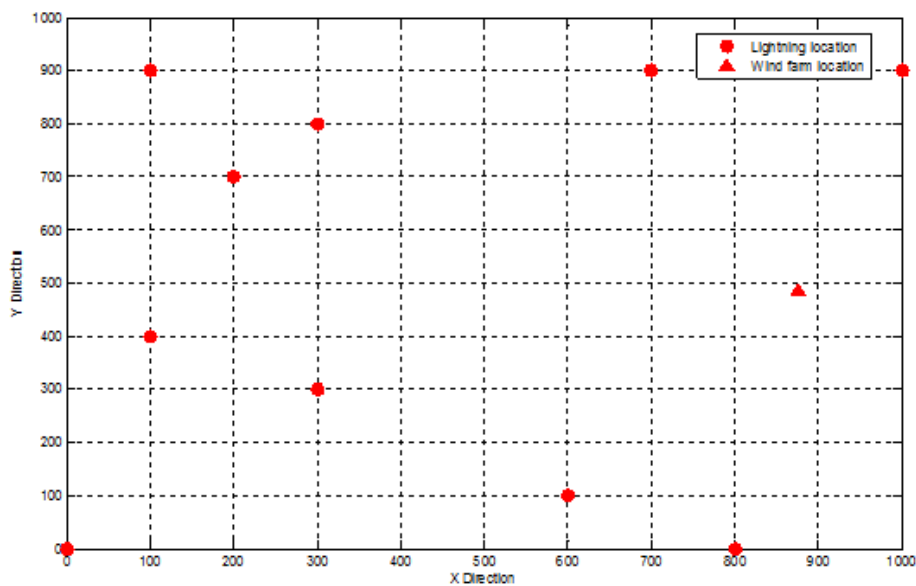

Figure 17. Ten distributed strikes and obtained wind farm location

## 6. Conclusions

This study presented a process for analyzing all components of wind farms including control systems, wind tower and boost transformer. Also, it simulated the induced transient voltages, GPR and capacitive induce voltage, resulting from lightning strikes. Based on local lightning characteristics and different grounding systems, four simulated cases were analyzed and discussed. The results show that the transient voltage of the upper and lower ends of the insulating layer of the control line was higher than that at the middle. The characteristics of the lightning currents were closely related to the voltage of the tower coupled to the control line. If the distance is insufficient, flashover may occur, causing damage. Overvoltage is reduced by about 95% and GPR is decreased by about 97% when using the proper design of the grounding system. The GPR is reduced by using the proper design of wind turbine ground system, while the induced voltage in control system is not affected. This paper presented a technique to identify the optimum location of wind turbine distant from the areas of maximum lightning incidence. Ant Colony Optimization (ACO) technique is implemented to find the optimum wind farm location. Ant Colony Optimization (ACO) technique can contribute on designing the best place for wind farms and can increase the capital on the protection from lightning in that area. Therefore, the cost of lightning protection can be reduced by using the simulation process proposed in this study depending on the wind turbine structure and the lightning characteristics of the installation site.

## References

- [1] IEC TR 61400-24. "Wind Turbine Generator Systems-Part 24: Lightning Protection". 2002.
- [2] Yasuda Y, Kobayashi H, Funabashi T. Surge analysis on wind farm when winter lightning strikes. *IEEE Trans Energy Conversion*. 2008; 23(1): 257-6.
- [3] JC Das. "*Transients in Electrical Systems, Analysis, Recognition and mitigation*". 2nd Edition, John Wiley and Sons, Inc. 2010.
- [4] Jheng-Lun Jiang, Hong-Chan Chang, Cheng-Chien Kuo and Cheng-Kai Huang. "Transient overvoltage phenomena on the control system of wind turbines due to lightning strike". *Renewable Energy*. 2013; 57: 181-189.
- [5] Amr M Abd\_Elhady, Nehmdoh A Sabiha and Mohamed A Izzularab. "Overvoltage Investigation of Wind Farm under Lightning Strokes". *IET Conference on Renewable Power Generation (RPG)*. 2011.
- [6] P Pinceti and M Giannettoni. "A Simplified Model for Zinc Oxide Surge Arresters". *IEEE Transactions on Power Delivery*. 1999; 14(2): 393-398.
- [7] MA Abd-Allah, Mahmoud N Ali and A Said. "A Proper Design of Wind Turbine Grounding Systems under Lightning". *World Academy of Science, Engineering and Technology, International Science Index 94, International Journal of Electrical, Robotics, Electronics and Communications Engineering*. 2014; 8(10): 1358 - 1365.
- [8] MA Abd-Allah, Mahmoud N Ali and A Said. "Towards an Accurate Modeling of Frequency-dependent Wind Farm Components under Transient Conditions". *WSEAS Transactions on Power Systems*. 2014; 9(Art. #40): 395-407
- [9] A Colomi, M Dorigo et V Maniezzo. "Distributed Optimization by Ant Colonies". *Actes de la première conférence européenne sur la vie artificielle*, Paris, France, Elsevier Publishing, book style. 1991: 134-142.
- [10] M Dorigo. "Optimization, Learning and Natural Algorithms". PhD thesis, Politecnico di Milano, Italie. 1992.
- [11] M Dorigo et LM Gambardella. "Ant Colony System: A Cooperative Learning Approach to the Traveling Salesman Problem". *IEEE Transactions on Evolutionary Computation*. 1997; 1(1): 53-66.
- [12] M Dorigo and Th Stu. "Ant Colony Optimization". tze.p. cm. "A Bradford book". Includes bibliographical references (p.).ISBN 0-262-04219-3.
- [13] Savdulla Kazazi and Kaamran Raahemifar. "Genetic algorithm technique on wind turbine and sensitive equipment placement against lightning". 2013 26th Annual IEEE Canadian Conference on Electrical and Computer Engineering (CCECE).